

Manufacture



de Buyer  
D E P U I S 1 8 3 0

Chaque recette a son secret\*



1.0 Qt — 1.0 L  
0.5 Qt — 0.5 L

COLLECTION 2023

# HELLO AND WELCOME TO "LA BRIGADE DE BUYER" !

We are an international group that designs and manufactures cooking and baking supplies for premium brands, that meet the needs of both catering professionals and home cooks.

Within our committed group, we combine skill and «savoir-faire» to encourage healthy and flavorful cooking with a positive impact. We promote a responsible multi-channel purchasing process, we are attentive to our customers needs, and we strive to create value for our customers.

De Buyer, Lion Sabatier, 32 Dumas, Scaritech, and Pebbly are complementary brands striving to support you in your innovative and committed culinary journey, to help you find success in your favorite recipes.



# LA BRIGADE DE BUYER



Thank you.

President  
La Brigade de Buyer



DE BUYER



SCARITECH



ROUSSELON  
DUMAS - SABATIER



N2J





French Manufacture of cooking and pastry utensils

# 193 years of history

1830

2023

Le Val d'Ajol  
Vosges (88)



25 000 m<sup>2</sup>

2 500 products  
49 patents



210 employees



France » 200



USA » 6



Germany » 4

OUR KNOW-HOWS



INNOVATION



FRENCH DESIGN AND MANUFACTURING



CRAFTSMANSHIP AND INDUSTRIAL KNOW-HOW



CONTROL OF MATERIALS

## International presence 94 COUNTRIES



## CSR CERTIFIED AT THE HIGHEST LEVEL

Having a positive impact on the environment and our society while promoting our region are the cornerstones of the de Buyer's approach, which is sustainable and committed.

### Some of the measures we've implemented :

- Setting up an apiary outside of our factory, an indicator of good environmental health. This initiative helps bring bees back in the Vosges region.
- Manufacturing durable and high-quality, French-made products (often with a lifetime warranty) that are long-lasting to promote responsible consumption.
- Recycling and reducing waste: once our nonstick fry pans are

done being used, we collect, disassemble, and recycle them.

- Local revitalization : our company supports and provides local jobs and promotes the region's economic development.

### We have also ...

- Created a waste water treatment plant on-site.
- Constructed new buildings with solar panels.
- Aided in reforestation by planting 1,400 trees locally.
- Eliminated plastic waste in our packaging.
- Created an internal Corporate Social Responsibility (CSR) task force.

And we are constantly continuing our efforts to improve !



Labelled

« Entreprise du Patrimoine Vivant »



# NEWS

## BOCUSE D'OR & TEAM FRANCE PARTNERSHIP

De Buyer has partnered with the largest culinary competition in the world, the Bocuse d'Or. The company has also actively been supporting Team France since 2019.

Being a Team France partner at the Bocuse d'Or not only means supporting a participant but also promoting the French gastronomy and taking part in a beautiful shared experience. It's a commitment that's all about excellence and the sharing of knowledge. In 2021, Davy Tissot, chef from Lyon and Meilleur Ouvrier de France, won the competition.



In 2021, Naïs Pirollet won the Bocuse d'Or FRANCE, and we've supported her during her training for the Bocuse d'Or throughout 2022. At age 24, she became the first female ever to represent France in this competition.

## SIRH+ BOCUSE D'OR 2023 FINAL PREMIUM PARTNER

## GAULT & MILLAU PARTNERSHIP

Gault & Millau Tour is promoting 11 regions of France by rewarding the most talented chefs and highlighting their restaurant, cuisine, service and savoir-faire. The Gault & Millau Young Talents Award is a prize in equipment and raw materials awarded to the most talented chefs to help them open their own restaurant.

De Buyer also manufactures the famous yellow plaque certifying that an establishment is part of the Gault & Millau selection.





# WHAT'S NEW



## ◀ REMOVABLE COOKWARE SET LOQY

Page 73

The iconic de Buyer collections also come with the option of removable handles :

- Alchimy multi-layer stainless steel
- Choc Extreme nonstick
- Mineral B carbon steel

## DE BUYER INNOVATIONS ▼

Page 73

LOQY stainless steel removable handle. "A la française" curved handle, and wooden side handles that clip on.



## ◀ UNIVERSAL STAINLESS STEEL LID FOR FRYING PANS

Page 13

*More information about our lids on pages 102-103*



## ▲ GLASS LIDS COMPATIBLE WITH ALCHIMY

Page 63



## ◀ OMELETTE PAN MINERAL B PRO

Page 9

## RUMBA MILL 21 CM ▶

Page 145

New colors : matte black and matte white.



## ▶ LE TUBE PRESSURE PASTRY SYRINGE + 2 NOZZLES ESSENTIAL SET

Page 219









# STEEL THAT STANDS THE TEST OF TIME

Steel frying pans are what our grandmothers used to use. These timeless pans are ideal for high-temperature cooking and take a simple and natural approach without any additional coating. We protect and nourish them with beeswax - it is then up to you to season your pan so it can truly flourish.

---

- 9 -  
Steel & beeswax  
MINERAL B

- 17 -  
Steel CARBONE PLUS

- 20 -  
Blue steel LA LYONNAISE

- 27 -  
Blue steel #OUTDOOR





**BOX Pizza**



Code	Designation	Lcm	Wcm	Hcm	Kg
4970.00		47,5	30	10	2

Box contents :  
 - 2 perforated pizza screens ø 28 cm for thick pizza  
 - 2 round trays made of blue steel ø 28 cm for thin crust pizza  
 - Pizza cutting wheel, stainless steel blade ø 10 cm  
 - Supple dough scraper  
 With tips from Philippe Laruelle, Maître Cuisinier de France

**BOX #crepesparty**



Code	Designation	Lcm	Wcm	Hcm
5615.01		47,5	30	10

Composition :  
 - Steel crepe pan MINERAL B ø26 cm, beeswax finish and strip steel handle  
 - Beechwood crepe spatula  
 - Silicone pastry brush







**BOX Steak Lover**



Code	Designation	Lcm	Wcm	Hcm	Kg
5610.03		47,5	30	10	2,85

- Composition :
- Steel frying pan MINERAL B ø26 cm, beeswax finish and strip steel handle
  - Pepper mill, beechwood with steel mechanism
  - Stainless steel tong L.24cm

**BOX #BRUNCHTIME Pancakes & Blinis**



Code	Designation	Lcm	Wcm	Hcm	Kg
5612.01		47,5	30	10	1,93

- Composition :
- 3-Blini pan MINERAL B made of steel, beeswax finish and steel handle - for 3 blinis ø10 cm
  - Ladle made of stainless steel and beechwood
  - Beechwood crepe spatula

THE WHITES

THE BLUES

MINERAL B  
· PRO ·

MINERAL B  
· BOIS ·

MINERAL B

CarbonePlus

# OUTDOOR

La Lyonnaise

Collection

Material of the body of the pan

White steel sheet

Blued steel sheet

Thickness

2,5 to 3 mm

2 mm

1 to 1,5 mm

Cooking methods

Searing / Grilling / Browning

Designed for cooking



Finish

Natural beeswax protection



Lightly oiled

Heat sources



Type of curved French-style handle

Cast stainless steel handle

Steel strip and wood handle

Steel strip handle

Fixing of the handle or base



Riveted + heat stop

Riveted

Spot welded

Use in the oven



Flash heat :  
10 minutes at 200 ° C

Dishwasher cleaning

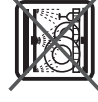

Profile

Flared and rounded lyonnaise shape : facilitates turning of foods

Diameter (cm)

20 to 32

12 to 40

12 to 50

12 to 36

14 to 45

Guarantee

Lifetime

PCB (packaging unit)

1

1

1

3 - 5

3

10



STEEL PAN WITH BEESWAX FINISH

- NATURAL ANTI-OXIDATION PROTECTION
- FAVOURED SEASONING
- IMPROVED NONSTICK QUALITIES

Robust : from 2,5 to 3 mm thick  
 RIVETED CAST STAINLESS STEEL HANDLE  
 possible oven cooking  
 Made in France  
 Suitable for all hotplates including INDUCTION

# MINERAL B • PRO •



Round frypan MINERAL B PRO with cast st/steel handle



Code	Designation	Øcm	Hcm	Th.mm	Bottom ø cm	Kg
5680.20		20	3,3	2,5	14	1,09
ACCESSORIES						
5680.24		24	3,5	2,5	17,5	1,44
5680.28		28	4	3	21	2,17
5680.32	With 2 handles	32	4,5	3	23	2,9

MINERAL B STEEL PAN WITH BEESWAX FINISH  
 riveted cast stainless steel handle  
 Robust : from 2,5 to 3 mm thick. Undistortable.  
 Suitable for all hotplates including INDUCTION and oven cooking

Round deep country pan MINERAL B Pro with cast st/steel handle



Code	Designation	Øcm	Hcm	Liters.	Th.mm	Kg
5684.24		24	7,7	2,5	2,5	2
5684.28		28	8,7	2,5	2,5	2,49



Omelette pan MINERAL B PRO with cast st/steel handle



new  
2023

Code	Designation	Øcm	Th.mm	Kg
5681.24		24	2,5	1,5
5681.28		28	3	2,25

OMELETTE pan with rounded shape to return easily omelettes and to slide them onto a plate without any problem. Perfect for delicious omelettes, crispy outside and soft inside.

STEEL PAN B BOIS WITH BEESWAX FINISH

- NATURAL ANTI-OXIDATION PROTECTION
- FAVOURED SEASONING
- IMPROVED NONSTICK QUALITIES

Robust : from 2,5 to 3 mm thick

Riveted handle made of steel and beechwood - Possible oven cooking 10 minutes / 200°C

The beech wood used is a wood coming from sustainably managed forests.

Suitable for all hotplates including INDUCTION

Made in France

'B Bois' products are exclusively sold via physical retailers.

# MINERAL B BOIS



Round frying pan MINERAL B BOIS



Code	Designation	Øcm	Hcm	Th.mm	Bottom ø cm	Kg
5710.20		20	3,2	2,5	14	1,05
5710.24		24	3,5	2,5	17,5	1,41
5710.26		26	4	3	18,5	1,93
5710.28		28	4	3	21	2,18
5710.32	with 2 handles	32	4,5	3	23	2,66



Round deep country pan MINERAL B BOIS



Code	Designation	Øcm	Lcm	Hcm	Liters.	Th.mm	ø bottom cm	Kg
5714.24		24	45,6	7,7	2,5	2,5	16,5	1,88



Round crepe pan MINERAL B BOIS



Code	Designation	Øcm	Lcm	Hcm	Th.mm	Bottom ø cm	Kg
5715.24		24	45,5	1,2	2,5	21	1,2
5715.26		26	47,8	1,3	2,5	22,5	1,4

3-blini pan MINERAL B BOIS



Code	Designation	Øcm	Th.mm	Kg
5712.03	3 blinis ø 10 cm	27	2	1,2

Wok MINERAL B BOIS



Code	Designation	Øcm	Lcm	Hcm	Th.mm	Kg
5718.28	wok - Base ø 8 cm - With 2 handles	28	50,4	9	2	1,76
5718.32	wok - Base ø 8 cm - With 2 handles	32	60,5	9,7	2	2,18
3329.10	Grid for wok ø 32 cm		34,5			0,14

The wok has forever been the universal Asian kitchen utensil, and it turns out to be ideal for a natural, dietetic cuisine, which needs very little fat and preserves the food's original taste. The 2mm (14 gauge) thickness provides a barrier against increasingly powerful heat sources and thus guarantees an easy-to-digest cuisine.

Glass lid with beechwood knob



Code	Designation	Øcm	Hcm	Kg
4111.20		20	7,5	0,4
4111.24		24	7,5	0,53
4111.28		28	7,5	0,7
4111.32		32	7,5	1



Suits on woks and country pans MINERAL B.

**CARBON STEEL PAN WITH BEESWAX FINISH**

- Beeswax finish protects against oxidation
- natural nonstick coating
- Seasoning required

Robust : from 2,5 to 3 mm thick

RIVETED STEEL HANDLE

For pan with steel handle:

Oven-safe 10 minutes / 200°C

Made in France

Suitable for all hotplates including INDUCTION

# MINERAL B



**Round frying pan MINERAL B**



Code	Designation	Øcm	Hcm	Th.mm	Bottom ø cm	Kg
5610.20		20	3,3	2,5	14	1
5610.24		24	3,5	2,5	17,5	1,39
5610.26		26	4	3	18,5	1,9
5610.28		28	4	3	21	2,15
5610.32	WITH 2 HANDLES	32	4,5	3	23	2,63
5610.36	WITH 2 HANDLES	36	5	3	26	3,53

**Round frying pan "GRILL" MINERAL B**



Code	Designation	Øcm	Hcm	Th.mm	Bottom ø cm	Kg
5613.26		26	4	2,5	18,5	1,37
5613.32		32	4,5	2,5	23	2,31



Steel steak frypan, flared edge MINERAL B

Code	Designation	Øcm	Th.mm	Bottom ø cm	Kg
5616.24		24	2,5	18	1,27
5616.28		28	2,5	21,3	1,63



Universal stainless steel lid, for frying pans

new  
2023

Code	Designation	Øcm	Th.mm	Kg
3460.02	Suitable for frypans ø 20 - 24 cm	25	0,8	0,35
3460.03	Suitable for frypans ø 26 - 28 cm	29	0,8	0,45
3460.04	Suitable for frypans ø 30 - 32 cm	34	0,8	0,61



Stronger design for stability.  
Sturdy without being heavy.  
De Buyer stainless steel knob: easy to grab and place upside down.  
Non-flat surface: limits excess water on kitchen countertop.  
Gloss polish finish.  
Made in France.



Round deep country pan MINERAL B



Code	Designation	Øcm	Hcm	Liters.	Th.mm	Bottom ø cm	Kg
5614.24		24	7,8	2,5	2,5	16,5	1,85
5614.28		28	8,7	4	2,5	19,5	2,47
5614.32	WTH 2 HANDLES	32	9,6	5,5	2,5	22,5	3

Round deep country pan MINERAL B with 2 handles

Code	Designation	Øcm	Hcm	Liters.	Th.mm	Bottom ø cm	Kg
5654.24		24	7,8	2,5	2,5	16,5	1
5654.28		28	8,7	4	2,5	19,5	1,8
5654.32		32	9,6	5,5	2,5	22,5	2,26





**Wok MINERAL B**



Code	Designation	Øcm	Lcm	Hcm	Th.mm	Kg
5618.24	wok - Base ø 8 cm	24	43,7	8	2	1,4
5618.28	wok - Base ø 8 cm	28	50,4	9	2	1,76
5618.32	wok - Base ø 8 cm - With 2 handles	32	60,5	9,7	2	2
3329.10	Grid for wok ø 32 cm		34,5			0,14
5618.40	wok - Base ø 11 cm- With 2 handles	40	69	10,4	2	2,75

The wok has forever been the universal Asian kitchen utensil, and it turns out to be ideal for a natural, dietetic cuisine, which needs very little fat and preserves the food's original taste. The 2mm (14 gauge) thickness provides a barrier against increasingly powerful heat sources and thus guarantees an easy-to-digest cuisine.

**Wok MINERAL B with 2 handles**



Code	Designation	Øcm	Lcm	Hcm	Kg
5619.28		28		9	1,75
5619.32		32		9,7	2
3329.10	Grid for wok ø 32 cm		34,5		0,14

The wok has forever been the universal Asian kitchen utensil, and it turns out to be ideal for a natural, dietetic cuisine, which needs very little fat and preserves the food's original taste. The 2mm (14 gauge) thickness provides a barrier against increasingly powerful heat sources and thus guarantees an easy-to-digest cuisine.

**Glass lid with stainless steel knob**



Code	Designation	Øcm	Kg
3429.14		14	0,24
3429.16		16	0,29
3429.18		18	0,35
3429.20		20	0,41
3429.24		24	0,58
3429.28		28	0,74
3429.32		32	1,1
3429.40		40	1,37



Omelette pan MINERAL B



Code	Designation	Øcm	Th.mm	Kg
5611.20		20	2,5	1,03
5611.24		24	2,5	1,35
5611.28		28	3	2,15

OMELETTE pan with rounded shape to return easily omelettes and to slide them onto a plate without any problem. Perfect for delicious omelettes, crispy outside and soft inside.

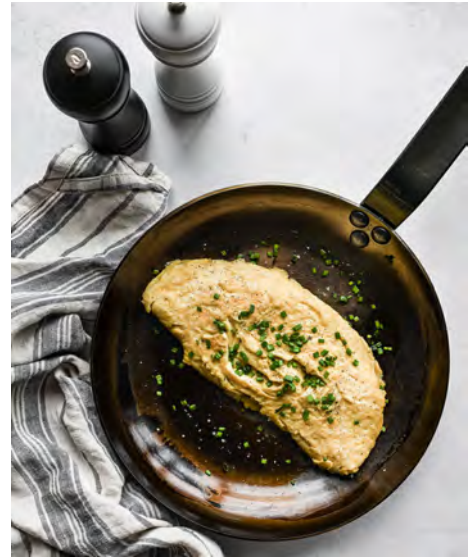

Round crepe pan MINERAL B



Code	Designation	Øcm	Lcm	Hcm	Th.mm	Bottom ø cm	Kg
5615.24		24	45,5	1,2	2,5	21	1,13
5615.26		26	47,8	1,3	2,5	22,5	1,33
5615.30		30	54,1	1,5	2,5	25,5	1,78

Blinis pan MINERAL B ELEMENT



Code	Designation	Øcm	Lcm	Th.mm	Bottom ø cm	Kg	PU
5612.12		12	24,1	2,5	9,5	0,43	5
5612.14		14	26	2,5	11,5	0,51	5



Pan for Poffertjes and mini-blinis MINERAL B



Code	Designation	Øcm	Lcm	Kg
5612.16		27	47,8	1,1

The Poffertjes pan to cook the famous Dutch mini-pancakes or also mini- blinis. 16 Poffertjes ø 4 cm

**3-blini pan MINERAL B**

Code	Designation	Øcm	Th.mm	Kg
5612.03	3 blinis ø 10 cm	27	2	1,11



**Rectangular grill pan with 2 st/steel riveted handles**



**Rectangular pan PLANCHA, 2 aluminium riveted handles**



Code	Designation	Lcm	Wcm	Hcm	Kg
5640.02		38	26	2,5	2,49

Born of the famous healthy and dietetic cooking method, the "plancha" is really practical to cook meat thanks to its wide area. Suitable on all heat sources and hot coals.

Code	Designation	Lcm	Wcm	Hcm	Th.mm	Kg
5640.01		38	26	2,5	2,5	2,21

This "Plancha" pan is used to grill meat without fat content. It is also perfect to cook scallop flesh, shrimps, fish, vegetables..The strong straight aluminium handles are firmly riveted. All heat sources including induction, oven cooking and hotcoals.

**Paella pan MINERAL B with 2 st/steel riveted handles**

Code	Designation	Øcm	Hcm	Th.mm	Bottom ø cm	Kg
5652.32	4 p.	32	4,2	3	23	2,5



**Oval roasting-pan with 2 st/steel riveted handles**

Code	Designation	Lcm	Wcm	Hcm	Th.mm	Bottom ø cm	Kg
5651.36		36	24	4,8	2,5	21	2,26





**STEEL pan**

2,5 to 3 mm thick for professional strong heat sources  
 Perfect heat conduction  
 Extra-strong handle  
 For pan with steel handle:  
 possible oven cooking 10 minutes / 200°C  
 Made in France

*Perfect for searing, frying, browning*

*Carbone Plus*



**Round "lyonnaise" frypan - Heavy quality steel**



Code	Designation	Øcm	Lcm	Hcm	Th.mm	Bottom ø cm	Kg	PU
5110.18		18	35,1	3	2,5	12	0,89	3
5110.20		20	36,8	3,2	2,5	14	1,03	3
5110.22		22	42	4	2,5	15,5	1,24	3
5110.24		24	44	3,5	2,5	17,5	1,31	3
5110.26		26	48,5	4	3	18,5	1,93	3
5110.28		28	50,5	4	3	20	2,1	3
5110.30		30	54	4,2	3	21,5	2,35	3
5110.32	With 2 handles	32	60	4,5	3	23	2,71	3
5110.36	With 2 handles	34	69,5	4,5	3	26	3,5	3
5110.40	With 2 handles	38	73	5,3	3	30	4,11	3
5110.50	With 2 handles	48	91	5,7	3	41	6,13	1

The "lyonnaise" profile pan has a high flared and curved skirt. This very distinctive shape, with no sharp angles, enables the food to slide easily from the frying pan onto a plate or dish. The strip steel handle is firmly riveted.  
 All heat sources.  
 Possible oven cooking : 10 minutes at 200°C.

**Round frying pan - Stainless steel cold handle**



Code	Designation	Øcm	Lcm	Hcm	Th.mm	Bottom ø cm	Kg	PU
5130.20		20	36,6	3,2	2,5	14	1	3
5130.24		24	43,7	3,5	2,5	17,5	1,39	3
5130.28		28	51	4	3	20	2,12	3
5130.32	With 2 handles	32	59,6	4,5	3	23	2,71	3

Ergonomic functional stainless tube handle, guaranteed not to heat up and firmly riveted. All hotplates including INDUCTION. Suitable for oven cooking. The "lyonnaise" profile pan has a high flared and curved skirt. This very distinctive shape, with no sharp angles, enables the food to slide easily from the frying pan onto a plate or dish.

**Fish frypan - Heavy quality steel**



Code	Designation	Lcm	Wcm	Hcm	Th.mm	Bottom ø cm	Kg	PU
5111.36	Oval - total L : 60 cm	36	26	4	2,5	21	2,3	3
5111.40	Oval - total L : 69,5 cm	40	28	5	3	23	3,32	3

Oval and oblong frying pans are the ideal shape for cooking whole fish. Note: the standard model has the handle riveted lengthways.

**Oval fish frying pan, steel**



Code	Designation	Lcm	Wcm	Hcm	Th.mm	Bottom ø cm	Kg	PU
5131.36	total L.50,3 cm	36	26	4,6	2,5	21	2,39	3

Handle is riveted on the short axis for "salamander special" model. All hotplates including INDUCTION

**Pancake pans - Heavy quality steel**



Code	Designation	Øcm	Lcm	Hcm	Th.mm	Bottom ø cm	Kg	PU
5120.18	2,5 mm th	18	36,2	1,1	2,5	15	0,71	5
5120.20	2,5 mm th	20	38,4	1,1	2,5	17	0,83	5
5120.22	2,5 mm th	22	42,2	1,3	2,5	19	1,02	5
5120.24	2,5 mm th	24	44,2	1,3	2,5	21	1,14	5
5120.26	2,5 mm th	26	50,2	1,3	2,5	22,5	1,37	5
GIANT CREPE PAN								
5120.30	2,5 mm th	30	54,2	1,7	2,5	25,5	1,79	5

Steel plate is the ideal metal for making crispy, tasty crepes. The low skirt of the frying pan allows crepes to be easily flipped and turned. The handle is welded (except for ø 30 cm whose handle is riveted)

**Steel blinis pan - Heavy quality steel**



Code	Designation	Øcm	Lcm	Wcm	Hcm	Th.mm	Perso	Kg	PU
5140.12	Blinis pan - 2,5 mm th	12	24	12,2	2	2,5	9,5	0,41	10

These frying pans allow you to make the well known Russian specialty blinis as well as fritters and pancakes.



**Round frypan, 2 stainless steel handles - Heavy quality steel**



Code	Designation	Øcm	Hcm	Th.mm	Bottom ø cm	Kg	PU
5113.24	2,5 mm th	24	4	2,5	17,5	1,2	3
5113.28	3 mm th	28	4,5	3	20	1,9	3
5113.32	3 mm th	32	5,5	3	23	2,4	3
5113.36	3 mm th	36	6	3	26	3	3
5113.40	3 mm th	40	6	3	30	3,78	3
5113.50	3 mm th	50	6	3	41	5,82	1

This extra-thick professional frying pan has two firmly welded handles. It has many different uses and proves ideal for paella because of its highly-flared shape, allowing liquid to evaporate quickly (boiling down).

Its heavy-gauge thickness allows food to simmer.

**WOK made of iron steel - Special induction cooker**



Code	Designation	Øcm	Lcm	Hcm	Th.mm	Kg	PU
5114.35	Polished finishing	35	60,5	8,5	1,5	1,46	3
3122.00		24		3,65	1	0,25	1

Typical Asian rounded form adapted to the wok induction cooker. Enables to seal and cook food with little fat for a dietetic and natural Asian cuisine. Optimized weight of the wok to cook effortless. Thanks to the thickness of 15/10° the wok is both solid and light to handle. Riveted steel handle. Guaranteed without coating.

support, the wok is steady on the plate.

The wok holder is suitable for rounded woks 3122.90 and 5114.35. Enables to use these woks on standard flat induction hotplates. Thanks of the special form with its handle

**Round "Grill" frypan with steel handle**



Code	Designation	Øcm	Lcm	Hcm	Th.mm	Bottom ø cm	Kg	PU
5530.26		26	48	4,3	2,5	18,5	1,42	3
5530.30		30	54	4,5	2,5	21,5	1,74	3

Ideal for searing meats using hardly any fat. The steel pan reaches high temperatures, caramelizing the meat juices to give your grilled meats flawless flavour. The ribbed base marks the meat and reduces the contact

area between pan and meat. The high side helps prevent from spatters. The thickness of the pan together with the ribbed base prevent shape loss.



**Rectangular grill pan**



Code	Designation	Lcm	Wcm	Th.mm	Kg	PU
5540.38		38	26	2,5	2,52	3

It is the perfect product for healthy cooking. Without fat, you will obtain really tender and grilled meat.

**Rounded steel deep-fryer without basket**



Code	Designation	Øcm	Lcm	Hcm	Liters.	Th.mm	Kg
5050.28		28	33,8	8	4	1,5	1,01
5050.32		32	38,9	9,3	6	1,5	1,29
5050.36		36	39,8	10,5	8,8	1,5	2,25
5050.40		40	42,5	13,1	12,2	1,5	2,86
5050.45		45	45,3	14,5	17,3	1,5	3,42
5050.50		50	50,3	16,4	23,5	1,5	4,35

Steel plate, being a very good spreader of heat, is perfect for the manufacture of deep frying vessels. This is the indispensable "SOS" utensil when the electric fryer breaks down. It's also very useful for other unforeseen uses.

Don't forget to order the corresponding frying basket separately.

**Stainless steel wire basket for ref. 5050**



Code	Designation	Øcm	Hcm	Kg
5051.28N		27	7,5	0,26
5051.32N		30	9,2	0,31
5051.36N		34	10,3	0,34
5051.40N		38,5	12	0,42
5051.45N		43	14,5	0,5

You can set the basket handles on the raised handles of the deep fryer so the cooking oil drains away perfectly. Make sure the basket is clear of the oil.

The basket is close-woven to ensure no food falls through the gaps. Mesh 8x 8 mm.

*La Lyonnaise*



**BLUE STEEL**

1 to 1,5 mm thick for less powerful heat sources

Semi-professional and domestic use

Quick heating time

Extra-strong handles- Welded

For pan with steel handle:

possible oven cooking 10 minutes / 200°C

For all heat sources except induction

Made in France

**Round "lyonnaise" frypan, blue steel**



Code	Designation	Øcm	Lcm	Hcm	Th.mm	Kg	PU
5020.14	1 mm th	14	26,2	3,3	1	0,25	10
5020.18	1 mm th	18	34,9	3,6	1	0,38	10
5020.20	1 mm th	20	36,9	4	1	0,46	10
5020.24	1 mm th	24	41,2	4,5	1	0,6	10
5020.26	1 mm th	26	46,3	4,5	1	0,69	10
5020.28	1,2 mm th	28	49,3	4,7	1,2	0,93	10
5020.30	1,2 mm th	30	54,4	5	1,2	1,04	10
5020.32	1,2 mm th	32	55,5	5,5	1,2	1,15	5
5020.36	1,5 mm th	36	65,8	6	1,5	1,72	5
5020.40	1,5 mm th	40	69,1	6,5	1,5	2,09	5
5020.45	1,5 mm th	45	83,2	7,5	1,5	2,81	1

The "Lyonnaise" is the traditional "granny-style" frying pan. The lightweight blue steel plate is suitable for low-power heat sources. This "lyonnaise" profile pan has a high flared and curved skirt, with no sharp angles, enabling the food to slide easily from the frying pan onto a plate or dish. The handle is welded.





**Pancake pan, blue steel**



Code	Designation	Øcm	Lcm	Hcm	Th.mm	Kg	PU
5303.18		18	36	1,5	2	0,58	10
5303.20		20	38	1,5	2	0,69	10
5303.22		22	41,8	1,5	2	0,8	10
5303.24		24	43,5	1,5	2	0,93	10

Blue steel plate is ideal for making crispy, tasty crepes. The low skirt of the frying pan allows crepes to be easily flipped and turned. The handle is welded.

**Box of 10 neoprene handle gloves for thermic protection**



Code	Designation	Lcm	Wcm	Hcm	Kg
4636.00		20,5	13	5,5	0,26









# #OUTDOOR

Preparing • Cutting • Spicing • Marinating  
Grilling • Searing • Cooking  
Meat • Fish • Vegetable  
Pizza • Baking

When it's finally summer,  
we all love to cook outside.

Whether it's on a grill, pizza oven or firepit, people love cooking outside  
during the best weather of the year.

When thinking about cooking, de Buyer utensils are essential, even for out-  
doors. Discover our product selection

-25 -  
Griddle

-27 -  
Blue steel frypan

-30 -  
Utensils



# PIZZA PLANCHA BBQ # OUTDOOR GRIDDLE GRILL

CONCEPT #OUTDOOR : POS & package



Code	Designation	Lcm	Wcm	Hcm
20.500	Totem #OUTDOOR		54,5	159
20.504	Recipes book #OUTDOOR			
POS pack 4 pcs :				
20.501 + 2 x 20.502 + 20.503				
20.501	Cardboard flag for display	60		18
20.502	Shelf cover	40		3,5
20.503	Cardboard chain			

- digital kits

#OUTDOOR CONCEPT

Merchandising dedicated to the #OUTDOOR collection

Seasonal in-store events.

Tools available to you for in-store promotions:  
dedicated packaging recipes - background visuals

Contact us for conditions of provision.



In the following pages, this symbol designates products with special OUTDOOR packaging



The blue carbon steel frying pan

The perfect pan to cook like a professional chef and rustle up delicious barbecue or plancha grills. Whether you want a tasty piece of grilled beef, generously sprinkled with freshly-milled pepper, or barbecue flavored summer vegetables, de Buyer has brought out the ideal frying pan.





Electrical griddle Plancha #OUTDOOR 60 X 40 cm

Gas Plancha #OUTDOOR 60 x 40 cm



Code	Designation	Lcm	Wcm	Hcm	Kg
	220 V				
	Norm CE and IPX4				
	6-10 p.				
<b>4420.00</b>	Griddle without lid	62	49	27	27

Code	Designation	Lcm	Wcm	Hcm	Kg
	Norm CE and IPX4				
	6-10 p.				
	While stocks last				
<b>4420.01</b>	Griddle without lid	62	52	27	26,4
<b>4420.021</b>	model for Germany	62	52	27	26,4

St/steel chassis. Enamelled cast iron plate dimension 60x40 cm.  
Easy cleaning.  
High performance: independent heating power with 2 radiants. 2 cooking areas.  
T° from 50 to 300°C.

High durability: stainless steel base - Splashproof with a satin finish.  
Hidden draining system: push/pull opening system.  
Norm IPX4 (resist to water splash).

Suitable for butane or propane gas. In accordance with European regulation. Stainless steel and steel chassis. Enamelled cast iron plate dim: 60x40 cm - Easy cleaning  
High performance: p-shaped stainless steel

burners with thermocouple protection. Integrated piezo at control buttons  
Hidden draining system: push/pull opening system.



Sideboard for griddle Plancha #OUTDOOR



Code	Designation	Lcm	Wcm	Hcm	Kg
4420.03		99	64	102	31,5

Top shelf 87x54 cm  
 2 shelves 43x36 cm  
 Backsplash with kitchen utensils rack 87x27 cm:  
 useful for hanging spatulas  
 EASY OPENING «push-pull» door system  
 EASY TO MOVE : 2 wheels with wheel covers and 1 handle

Lid for griddle Plancha #OUTDOOR L.60 cm

Cover for griddle Plancha #OUTDOOR L.60 cm without lid



Code	Designation	Lcm	Wcm	Hcm	Kg
4420.50	Stainless steel	61	47	16	5,6
4420.51	Black Epoxy	61	47	16	5,6

Code	Designation	Lcm	Wcm	Hcm	Kg
4420.60		62	52	27	0,5

Dome cover with stainless steel knob and vent hole



Code	Designation	Øcm	Hcm	Th.mm	Kg
3374.30		32,5	15	0,7	0,78

This dome cover is ideal for steaming meat, vegetables, fish, shellfish, tarts or clafoutis on a griddle.  
 - gentle cooking method that prevents evaporation, preserves nutrients and enhances flavors.  
 - healthy cooking method with very little fat.  
 The cover can also be used to keep food warm. The steam hole ensures pressure release.



# PIZZA PLANCHA BBO # OUTDOOR GRIDDLE GRILL

## BLUE STEEL - EXTRA-STRONG quality

2 mm thick for professional medium heat sources  
 Perfect heat conduction  
 Welded extra-strong handles  
 For pan with steel handle:  
 possible oven cooking 10 minutes / 200°C  
 All heat sources (induction at moderate T°)  
 Made in France

Perfect for SEARING, FRYING, BROWNING



### Frying pan, blue steel



Code	Designation	Øcm	Lcm	Hcm	Th.mm	Kg	PU
5400.20		20	37	4,2	2	0,95	6
5400.24		24	43,5	4,5	2	1,26	6
5400.28		28	50	5	2	1,66	6
5400.32		32	56	5,5	2	2,1	3
5400.36		36	67	6	2	2,57	3
	BLINIS PAN						
5440.12		12	24	2	2	0,33	20

This "lyonnaise" profile pan made from 2mm (14 gauge) blue steel plate gives very good heat spread. It has a high flared and curved skirt. This very distinctive shape, with no sharp angles, enables the food to slide easily from the frying pan onto a plate or dish. The strip steel handle is firmly riveted.

### Round "Country" frypan , 2mm blue steel



Code	Designation	Øcm	Lcm	Hcm	Liters.	Th.mm	Kg	PU
5414.20		20	39,5	6	1,7	2	1,19	3
5414.24		24	46,5	6,8	2,5	2	1,58	3
5414.28		28	51,5	7	4	2	1,96	3
5414.32	With 2 handles	32	66,5	8	5,5	2	2,46	3

Between the curved sauté pan and the "Lyonnaise" profile frying pan, this high-sided pan is ideal for all styles of cooking, including frying, searing, grilling. It can be used to prepare large quantities of ingredients and its high sides reduce the amount of juice spat out when cooking meats. Ideal for sauteed potatoes.



**Perforated vegetable pan, blue steel**



Code	Designation	Øcm	Th.mm	Kg	PU
5490.00	with 1 riveted handle	28	2	1,3	3
5408.28	with 2 handles	28	2	1,3	3

The perforations ensure direct cooking and when cooking on coals give your food the perfect barbecue flavor.

**Chestnut pan with side ventilation**



**Chestnut pans, blue steel**



Code	Designation	Øcm	Hcm	Th.mm	Kg	PU
5493.28		28	4,7	1,1	0,91	10

Chestnut pan with side ventilation for improved heat circulation: an exclusive process allows this chestnut pan to be used on all types of hotplates, including gas and induction hob at moderate T°.

The grooved bottom allows the chestnuts to roast better.

Code	Designation	Øcm	Th.mm	Kg
5490.28		28	1	0,7
5491.28		28	1	1,24

The chestnut pan with holes in the bottom is a traditional utensil, always made out of steel plate for ruggedness. This design of chestnut pan is exclusively for use on hot coals. Welded handle.

**Pancake pan, blue steel**



Code	Designation	Øcm	Lcm	Hcm	Th.mm	Kg	PU
5303.18		18	36	1,5	2	0,58	10
5303.20		20	38	1,5	2	0,69	10
5303.22		22	41,8	1,5	2	0,8	10
5303.24		24	43,5	1,5	2	0,93	10

Blue steel plate is ideal for making crispy, tasty crepes. The low skirt of the frying pan allows crepes to be easily flipped

and turned. The handle is welded.







**Paella pan, blue steel**



Code	Designation	Øcm	Lcm	Hcm	Th.mm	Kg	PU
5023.20		20			1		3
5023.34	6 portions - 1,5 mm th	34	42	4,5	1,5	1,43	3
5023.37	8 portions - 1,5 mm th	37	44,4	5	1,5	1,61	3
5023.42	12 portions - 1,5 mm th	42	49,5	5,5	1,5	2,05	3
5023.47	15 portions - 1,5 mm th	47	55	6	1,5	2,64	3
5023.60	25 portions - 1,5 mm th	60	68	6,5	1,5	3,91	1

The paella dish is not only typical but also has lots of other possible uses: it goes on the hotplate but also in the oven if size allows, and in certain establishments, it goes on the table too. This dish is of medium height and makes it easy to prepare paella or other dishes.

**Chrome steel burner tripod**



Code	Designation	Lcm	Wcm	Hcm	Kg
0820.00N		59	55	66,5	2,17

The tripod provides a fixed support for the "paella special" gas burner, giving a stable cooking surface when making paellas out in the open. It adapts to burner size up to ø 60/70 cm and bears about 60 kg.

**Gas burner, enamelled steel**



Code	Designation	Øcm	Lcm	Hcm	Kg
0816.40N	For paella pan 60-100 cm- 11,7 KW	41	69	11,1	2,51
0816.50N	For paella pan 60-100 cm - 14 KW	50	84,2	12	3,19
0816.60N	For paella pan 60-100 cm- 19,25 KW	60	94,7	13	3,78

In accordance with European regulations  
Gas burner delivered without adapter  
Standard model with a 37-millibar pressure  
Indicate with order the country where the burner will be used to adapt it.

This burner has independent and separately controllable flame rings and allows a dish or other receptacle to be heated wherever needed and without over-bulky or costly equipment. It's the ideal complement to the paella dish for alfresco meals or for use in reception rooms where improvised "kitchens" or "buffets" are laid out. The gas burner is suitable for both butane and propane.

**Paella pan "Viva España", 2 red handles, steel**



Code	Designation	Øcm	Hcm	Th.mm	Kg	PU
5026.24N	1 portion	24	3,5	1	0,4	6
5026.28N	3 portions	28	3,7	1	0,51	6
5026.32N	5 portions	32	4	1	0,68	6
5026.36N	7 portions	36	4	1	0,97	6
5026.40N	9 portions	40	4,4	1	1,28	6
5026.46N	12 portions	46	5	1	1,9	4
5026.50N	14 portions	50	5	1	2,22	4
5026.60N	19 portions	60	5	1	4,09	4
5026.70N	25 portions	70	5	1	7	1
5026.80N	40 portions	80	5,2	1	9,3	1
5026.90N	50 portions - 4 handles	90	6,2	1,5	12	1

From 1.0 to 1.5mm thick (16 to 20 gauge), this paella dish is modeled on the typical Spanish shape, with a relatively low skirt.

The hammered bottom gives this item a distinctive look.

**KOBRA V AXIS : Professional fruit and vegetable slicer with pusher**



Code	Designation	Lcm	Wcm	Hcm	Kg
2011.01	Complete with pusher - Black	36,5	12,2	8	0,66
2011.41	Complete with pusher - Red	36,5	12,2	8	0,66
SPARE PARTS:					
2011.55	Pusher alone				

- V-shaped blade: the blade penetrates the product easily.  
 - Optimised cutting angle at 19,3°. Cuts easily and perfectly all fruits and vegetables, even the softest ones (tomatoes, pears, etc.).  
 - Micro-serration of the blade enables the thinnest cut of fruit/vegetable with skin and preserves their flesh composition.

thumb wheel integrated at the end of the handle allows the adjustment of the thickness up to 5 mm. - St/steel ramp  
 - COMPACT: the pusher clips on for easy storage.  
 - SAFE Protective pusher. Silicone moulded anti-sliding ergonomic handle. Anti-skid feet.

- PRACTICAL & EASY: easy to adjust the height of the cut: the

**Asian Chef's knife**



Code	Designation	Lcm	Wcm	Hcm	Kg
4280.15	L. 15 cm	28,6	4,9	2	0,16
4280.17	L. 17 cm	30	5,5	1,8	0,18

This 15cm Asian Chef's knife is very light and sharp and easy to maneuver for light quick cutting tasks in busy kitchens. It is also

designed to be ideal for young cooks or for small hands.

**Utility knife L. 14 cm**



Code	Designation	Lcm	Wcm	Hcm	Kg
4285.14		26,7	2	3	0,14

Small chopping/slicing knife for many light meat/vegetable jobs for chefs and home cooks.

**Flat bottom bowl**



Code	Designation	Øcm	Hcm	Liters.	Th.mm	Kg
3250.20		20	10	2	0,8	0,24
3250.24		24	11,2	3,5	1	0,4

Bowls for professional use, as much for their capacity as for the quality and thickness of the stainless steel used. They have an open rolled rim: rolled for handling without injury and open for improved hygiene. Polished finish.

**Flat-edge rectangular deep dish, conical**



Code	Designation	Lcm	Wcm	Hcm	Liters.	Th.mm	Kg	PU
3283.27		27	22	4	1,9	1	0,63	10
3283.30		30	25	4,3	2,6	1	0,79	10



**Utility tong L.40 cm**



Code	Designation	Lcm	Th.mm	Kg	PU
4788.40N		40	0,5	0,2	12

**Stainless steel tweezer with curved end**



Code	Designation	Lcm	Kg
4239.35		35	0,17



Skewers, stainless steel

Code	Designation	Lcm	Th.mm	Kg
3401.25	Set of 10	25	2	0,01
3401.30	Set of 10	30	2	0,01
3401.35	Set of 10	35	2	0,01
3401.40	Set of 10	40	2	0,02



Easily slice through meat and vegetables thanks to the bevelled tips. Made of flat stainless steel wire, food won't slip off during cooking. Robust and reusable.

Silicone brush

Code	Designation	Lcm	Wcm	Kg
4807.25N		25	3	0,04



Hygienic brush. Easily cleanable. T° resistance until 250°C.



Triangular spatula FKOfficium

Code	Designation	Lcm	Wcm	Kg
4233.01	L. blade 8 cm	26,5	8	0,11



With its special shape, this spatula lets you clean grids and hotplates. Its width and sharp angles also allow you to cut or spread pasty substances or to peel chocolates off their baking sheets.

Stainless steel flexible turner FKOfficium

Code	Designation	Lcm	Wcm	Kg
4235.00	L.blade 17 cm	31	7,8	0,1



This food turner is made from forged stainless steel. Its springiness makes food easy to handle and turn.

**Cranked spatola FKofficium inox**

Code	Designation	Lcm	Wcm	Kg
4232.00	L. blade 12 cm	30	9	0,14



High resistance thanks to the thick stainless steel of the blade. The bevelled blade allows easy sliding under food. Wide angled design ensures you can easily turn any piece of meat or kind of burger.

**Dredger, stainless steel**

Code	Designation	Øcm	Hcm	Liters.	Kg
4783.03N	Spices dredger - large holes 2,5 mm	7	10	0,31	0,14



**Stainless steel round ring ø 8 cm**



Code	Designation	Øcm	Hcm	Th.mm	Kg	PU
3989.08		8	4,5	0,8	0,08	6

Enables you to cook your flans and gratins directly and quickly on a grill.

**Pizza cutting wheel**



Code	Designation	Øcm	Th.mm	Kg
4970.10N	Pizza cutting wheel	10	1	0,17

This particularly sturdy pizza cutter has an ergonomic handle for a firm grip. Its stainless steel beveled blade allows pizza to be easily cut into portions.

**Round pizza tray, heavy blue steel**



Code	Designation	Øcm	Th.mm	Kg	PU
5350.28		28	1	0,52	5

The plaque will not distort and ensures good heat transmission. This steel plate has a high-quality surface that will not stain pastry bottoms; it is micro-roughened, creating an air mattress between the food to be cooked and the metal. Ideal for pizzas.





**Spices lacquered mill RUMBA 20 cm, ceramic mechanism**



Code	Designation	Hcm	Kg
C030.213232	Red	21	0,35
C030.213333	Black	21	0,35

Ceramic mechanism suitable for various spices. This range of classical mills is made of beech wood. The wood is lacquered : one coat of white lacquer then three coats of the color. The glossy lacquered finish and the vitamin shades bring a colourful touch and brighten up the kitchen and table.

**Preparation dish with 6 cells, stainless steel**



Code	Designation	Lcm	Wcm	Hcm	Th.mm	Kg
3221.06		40	30	1,6	0,8	0,7

Ideal dish for preparing different dishes and separating them. Robust, resistant and undeformable stainless steel. 6 cells. Rounded corners for easy maintenance. Gloss polished finish. Hygienic and durable.

**Mug with 2 folding handles, stainless steel**



Code	Designation	Lcm	Wcm	Hcm	Liters.	Th.mm	Kg	PU
3979.00		13,6	9	9,5	0,7	0,7	0,21	10

The mug is a piece of camp equipment meant for a soldier's use. This stainless steel model is especially robust and hygienic and is easy to keep clean. The two handles fold away to take up less room.

**2-level smoker oven for hot and cold smoking - Stainless steel**



Food is subjected, over a prolonged period, to smoke which has an antiseptic effect and increases shelf life, at the same time enhancing the taste. Smoking gives food a woody taste. More specifically, you can smoke meat (steak, chops, filet mignon, etc.), poultry (chicken, duck, etc.), charcuterie (essentially ham, bacon, large sausages, small sausages, andouilles [spicy sausages]) and fish (salmon, trout, eel, mackerel, etc.). The principle lies in exposing food to smoke at different temperatures, depending on the desired result.

Sawdust is sterilized and dust free. Guaranteed without chemical. Sawdust HB50/1000. Grain size : 0.5 to 1.0mm. Humidity 8 to 12 %. In compliance with the standards DIN ISO 9001.

Code	Designation	Lcm	Wcm	Hcm	Kg
3441.60	large 60 x 40 cm	60	40		
3441.00	small 31 x 31 cm	31	31	20	7,3
	Composition :				
	Smoking chamber with lid				
3441.93	st/steel grid for smoker 31x31 cm				
3441.91	Oven and lid				
3441.90	Fire pit				
3441.92	Aluminium telescopic and flexible pipe				
	One thermometer				
	500 g. of sawdust				
	2 removable feet				
	Delivered with smoking advice and recipes				
	To be assembled				
	Beech sawdust for food smoking:				
4441.01	Bag of 0,5 kg				0,51
4441.15	Bag of 15 kg				15,1





de puyser  
ESTABLISHED 1954





# OUTSTANDING NON-STICK PANS

Our non-stick ranges are recommended for low-temperature cooking as they cook up dishes with great care without altering food. These pans are thick and have non-hazardous coatings allowing you to cook without using fat nor oil.

De Buyer will even recycle them.

---

- 37 -

Cast aluminium INDUCTION  
CHOC EXTREME

- 40 -

Forged aluminium INDUCTION  
CHOC BBOIS & CHOC INTENSE

- 44 -

Aluminium CHOC RESTO INDUCTION

- 47 -





Aluminium CHOC

- 51 -

Aluminium CHOC ACCESS

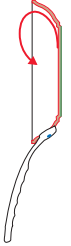
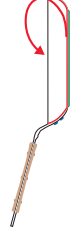
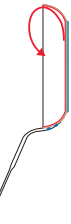
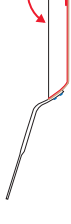

# NON-STICK RANGE

	FORGED ALUMINIUM			ALUMINIUM		
Collection	<b>CAST ALUMINIUM</b> <b>CHOC EXTRÊME</b> 	<b>CHOC BOIS</b> <b>• BOIS •</b> 	<b>CHOC INTENSE</b> 	<b>CHOC RESTO INDUCTION</b> 	<b>CHOC CLASSIC</b> 	<b>CHOC ACCESS</b> 
Thickness	7 mm	4 mm	4 mm	4 to 5 mm	3,3 to 5 mm	3 to 4 mm
Cooking methods	Reheating / Frying / Simmering					
Designed for cooking						
Non-stick coating resistance	LONG LASTING RESISTANCE					
Heat sources						
Base of the utensil	Welded and brazed induction disc	Forged aluminium induction disc	Forged aluminium induction disc	Forged honeycomb induction disc	Pressed aluminium	
French-style curved handle	Steel strip and wood handle	Stainless steel strip handle	bakelite removable handle		Steel strip handle	
Fixing of the handle or base	Riveted + heat-stop 					Riveted
Use in the oven	Flash heat : 10 min at 200° C 	Max 250° C (except grill) 	Max 250° C (except grill) 		Flash heat : 10 min at 200° C 	
Dishwasher cleaning	Occasional to avoid affecting the non-stick properties 					
Diameter (cm)	18 to 36	20 to 36	20 to 36	20 to 32	12 to 40	20 to 40
PCB (packaging unit)	1	1	1	3	3	3



CHOC EXTREME

Cookware made of real pressure cast aluminium  
 Improved higher quality non-stick coating  
 ULTRA REINFORCED EXTREME HARD = longer lifetime  
 Undistortable thick magnetic bottom  
 All heat sources including induction

*For simmering, reheating and cooking delicate dishes*

# CHOC EXTREME



**Round non-stick frypan CHOC EXTREME with riveted cast st/steel handle**

Code	Designation	Øcm	Lcm	Hcm	Th.mm	Bottom ø cm	Kg
8300.20		20	40	4,5	3	14	0,8
8300.24		24	46,5	4,5	3	16	1,16
8300.28		28	54	4,5	3	18,5	1,45
8300.32	with 2 handles	32	63	4,5	3	22	2,27



CHOC EXTREME is made from pressure cast aluminium and is covered with the highest quality non-stick coating which is consolidated by a PTFE projection. It stands up excellently to deformation, knocks, and sudden changes in temperature. This frying pan is ideal for providing regular cooking conditions as its very thick base cuts out sudden, unwelcome reactions when too much heat is applied. The ergonomic cast st/steel handle is firmly riveted.

CHOC EXTREME nonstick pan with removable handle is also available  
 See page 76

**Round nonstick frypan CHOC EXTREME with tubular stainless steel handle**

Code	Designation	Øcm	Hcm	Th.mm	Bottom ø cm	Kg
8310.20		20	4,2	3	12,5	0,8
8310.24		24	4,2	3	16	1,2
8310.28		28	4,6	3	18,5	1,8
8310.32		32	4,6	3	22	2
8310.36	with 2 handles	36	4,6	3	23	2,5

CHOC EXTREME is made from pressure cast aluminium and is covered with the highest quality non-stick coating which is consolidated by a PTFE projection. It stands up excellently to deformation, knocks, and sudden changes in temperature. This

frying pan is ideal for providing regular cooking conditions as its very thick base cuts out sudden, unwelcome reactions when too much heat is applied. The ergonomic st/steel handle is firmly riveted.

**Non-stick sauté-pan with riveted cast st/steel handle**

Code	Designation	Øcm	Lcm	Hcm	Liters.	Th.mm	Bottom ø cm	Kg
8304.20		20		6,2	1,5	3	12	0,95
8304.24		24	47,2	6	2,5	3	16	1,45
8304.28		28	53,5	6	3,5	3	19,5	1,71

Non-stick coating on a hard stainless backing, abrasion and scrape resistant. This sauté pan is ideal for simmering food. Ergonomic functional cast stainless steel handle firmly riveted. All hotplates including INDUCTION

**Mould for upside down pie "Tatin", non-stick cast aluminium CHOC EXTREME Induction**

Code	Designation	Øcm	Hcm	Bottom ø cm	Kg
8320.24	4/6 p.	24	5	16	0,82
8320.28	6/8 p.	28	5,5	18,5	1,2

This mould proves ideal for Tatin tarts, since it allows you to form a caramel layer directly in the mould while it's on the heat. Once the caramel is formed in the mould, just add the apple slices, cover with pastry, and place the mould in the oven. Pressure cast

aluminium is ideal for providing regular cooking conditions and the thick bottom stands up excellently to deformation.

**Stewpan, 2 handles, with glass lid - CHOC EXTREME**

Code	Designation	Øcm	Lcm	Hcm	Liters.	Th.mm	Bottom ø cm	Kg
8311.20		20	27	8,5	2,8	3	14,5	1,37
8311.24		24	33,5	9,5	4,7	4	16,5	1,76
8311.28		28	37	10	7	4	18,5	2,45

Suits with its lid for oven cooking.

**Wok CHOC EXTREME, with 2 handles**

Code	Designation	Øcm	Lcm	Hcm	Th.mm	Bottom ø cm	Kg
8317.00	Wok	32		11	3	18	1,62
3329.10	Grid for wok ø 32 cm			34,5			0,14

The glass lid 3429.32 suits on the wok.



Sauté-pan, 2 handles, without glass lid - CHOC EXTREME

Code	Designation	Øcm	Lcm	Hcm	Th.mm	Bottom ø cm	Kg
8313.20	Sauté-pan without lid ø 20 cm	20	27	6	3	12,5	0,96
8313.24	Sauté-pan without lid ø 24 cm	24	31	6	4	15,5	1,28
8313.28	Sauté-pan without lid ø 28 cm	28	35	6,5	4	19,5	1,74
8313.32	Sauté-pan without lid ø 32 cm	32	40,5	7,5	4	22	2,16
8313.36	Sauté-pan without lid ø 36 cm While stocks last	36		8,5	4	23	2,75



The two-handed sauté dish allows quick browning of food. It has the same uses as a one-handed sauté pan but turns out to be more practical to handle and takes up less space when stored away or when on the burner.



Glass lid with stainless steel knob



Code	Designation	Øcm	Kg
3429.16		16	0,29
3429.20		20	0,41
3429.24		24	0,58
3429.28		28	0,74
3429.32		32	1,1
3429.36		36	1,2

These glass lids with stainless steel button fit the CHOC EXTREME range of pans and sauté pans. Suitable for oven cooking.

Box of 10 neoprene pairs of handle gloves for thermic protection

Code	Designation	Lcm	Wcm	Hcm	Kg
4636.10	Small size 7 cm	24	14,5	6	0,36
4636.20	Large size 11 cm for for ø36 cm	24	14,5	6	0,44



Fits to the handles of stewpan, sauté-pan etc. to handle without any risk of burning



**NONSTICK PAN CHOC B BOIS - FORGED ALUMINIUM**

The forging process, undertaken during manufacturing, makes the aluminum harder and more durable.

Riveted handle made of steel and beechwood.

The beech wood used is a wood coming from sustainably managed forests.

The high-end PTFE coating preserves its non-stick properties for longer (50% longer lifetime) allowing to cook healthier dishes using less fat.

Suitable for all hotplates including INDUCTION - Possible oven cooking 10 minutes / 200°C  
Made in France

*'B Bois' products are exclusively sold via physical retailers.*

**CHOC B  
• BOIS •**



**Round nonstick frypan Choc B BOIS**

Code	Designation	Øcm	Lcm	Hcm	Th.mm	ø bottom cm	Kg
8780.20		20	36,7	3,2	4	14	0,81
8780.24		24	44	3,7	4	16,6	1,06
8780.28		28	50	4	4	18	1,34
8780.32		32	57	4,5	4	20	1,73



Strip steel handle with beech wood treated with beeswax for the nonstick pan CHOC B BOIS. Nonstick coating on the whole pan, on inner and outer sides.

Optimum resistance to abrasion + better non-stick and slip qualities.

Suitable for all heat sources including induction. Possible oven cooking 10 minutes / 200°C.

Nonstick pans are ideal for simmering reheating cooking and cooking delicate dishes.



Rounded sauté-pan CHOC B BOIS



Code	Designation	Øcm	Th.mm	ø bottom cm	Kg
8788.24		24	4	16,6	1,28
8788.28		28	4	22	1,55

Glass lid with beechwood knob



Code	Designation	Øcm	Hcm	Kg
4111.20		20	7,5	0,4
4111.24		24	7,5	0,53
4111.28		28	7,5	0,7
4111.32		32	7,5	1

Fits on all the pans of the CHOC B BOIS range.

Round crepe pan CHOC B BOIS



Code	Designation	Øcm	Th.mm	ø bottom cm	Kg
8785.26		26	4	18	0,87
8785.30		30	4	22	1,19

**NONSTICK PAN CHOC INTENSE  
FORGED ALUMINIUM**

Riveted stainless steel handle - Gloss finish.

The forging process, undertaken during manufacturing, makes the aluminum harder and more durable

A next generation ultra-thick reinforced non-stick coating guarantees unparalleled effectiveness and high resistance to abrasion

The high-end PTFE coating preserves its non-stick properties for longer time (50% longer lifetime) allowing to cook healthier dishes using less fat.

Suitable for all hotplates including INDUCTION - Possible oven cooking. Easy to clean. Made in France

**CHOC  
INTENSE**



**Round nonstick frypan CHOC INTENSE, stainless steel handle**



Code	Designation	Øcm	Th.mm	ø bottom cm	Kg
8760.20		20	4	14	0,65
8760.24		24	4	16,6	0,9
8760.28		28	4	20,6	1,19
8760.32		32	4	22	1,44

**Glass lid with stainless steel knob**



Code	Designation	Øcm	Kg
3429.20		20	0,41
3429.24		24	0,58
3429.28		28	0,74
3429.32		32	1,1

These glass lids with stainless steel button fit the CHOC INTENSE range of pans. Suitable for oven cooking.





**Rounded sauté-pan CHOC INTENSE**



Code	Designation	Øcm	Th.mm	ø bottom cm	Kg
8768.24		24	4	16,6	1,18
8768.28		28	4	22	1,45

**Round crepe pan CHOC INTENSE**



Code	Designation	Øcm	Th.mm	ø bottom cm	Kg
8765.26		26	4	18	0,84
8765.30		30	4	22	1,11



CHOC INTENSE nonstick pan with removable handle is also available  
See page 80



**DISPLAY PODIUM CHOC Retail ref 10.8300**

for the promotion of the nonstick ranges  
CHOC EXTREME / CHOC B BOIS / CHOC INTENSE  
Dimensions 30,5 x 29,5 x ht 47 cm  
Suitable for ø 24 cm

PROFESSIONAL PANS  
 MADE OF NON-STICK ULTRA THICK ALUMINIUM  
 FORGED INDUCTION BOTTOM  
 HONEYCOMBED & EMBEDDED  
 = perfect heat distribution and optimal fit

Improved PTFE 5-LAYER coating  
 for a better resistance to abrasion and to heat  
 Optimum non-stick and slip qualities  
 Riveted steel handle: possible oven cooking 10 minutes / 200°C

*For simmering, reheating and cooking delicate dishes*

# CHOC RESTO INDUCTION



**Round nonstick frypan CHOC Resto Induction made of thick aluminium**

Code	Designation	Øcm	Lcm	Hcm	Th.mm	Bottom ø cm	Kg
8480.20		20	36,7	3	5	12	0,78
8480.24		24	43,5	3,5	5	14	1,03
8480.28		28	50	3,8	5	18	1,31
8480.32		32	55,6	4,5	5	20	1,7
8480.36		36	66	4,7	5	24	2,45



The professional non-stick aluminium frypan CHOC RESTO INDUCTION is covered with a high-quality improved PTFE coating . Therefore, it is resistant to abrasion and to heat. The strip handle is firmly riveted and covered with a heat-resistant epoxy. All hotplates.



**Non-stick aluminium frypan CHOC Resto Induction with red handle - HACCP**



Code	Designation	Øcm	Lcm	Hcm	Th.mm	ø bottom cm	Kg
Red handle for red meat							
8450.20		20	36,7	3	5	12	0,78
8450.24		24	43,5	3,5	5	14	1,03
8450.28		28	50	3,8	5	18	1,31
8450.32		32	55,6	4,5	5	20	1,7

The traditional non-stick frypan CHOC made of thick aluminium is equipped with a heat resistant coloured cast strip handle. Practical and hygienic, this new system avoids cross contamination (transfer of bacteria from one food to another). You simply cook different foods in different frypans. It is helpful in professional kitchens that must observe strong hygiene regulations.

**Non-stick aluminium frypan Choc Recto Induction with green handle -HACCP**



Code	Designation	Øcm	Lcm	Hcm	Th.mm	ø bottom cm	Kg
Green handle for vegetables							
8460.20		20	36,7	3	5	12	0,78
8460.24		24	43,5	3,5	5	14	1,03
8460.28		28	50	3,8	5	18	1,31
8460.32		32	55,6	4,5	5	20	1,7

The traditional non-stick frypan CHOC made of thick aluminium is equipped with a heat resistant coloured cast strip handle. Practical and hygienic, this new system avoids cross contamination (transfer of bacteria from one food to another). You simply cook different foods in different frypans. It is helpful in professional kitchens that must observe strong hygiene regulations.

**Non-stick aluminium frypan CHOC Resto Induction with yellow handle -HACCP**



Code	Designation	Øcm	Lcm	Hcm	Th.mm	ø bottom cm	Kg
Yellow handle for white meat							
8470.20		20	36,7	3	5	12	0,78
8470.24		24	43,5	3,5	5	14	1,03
8470.28		28	50	3,8	5	18	1,31
8470.32		32	55,6	4,7	5	20	1,7

The traditional non-stick frypan CHOC made of thick aluminium is equipped with a heat resistant coloured cast strip handle. Practical and hygienic, this new system avoids cross contamination (transfer of bacteria from one food to another). You simply cook different foods in different frypans. It is helpful in professional kitchens that must observe strong hygiene regulations.

**Non-stick aluminium frypan CHOC Resto Induction with blue handle -HACCP**



Code	Designation	Øcm	Lcm	Hcm	Th.mm	øbottom cm	Kg
Blue handle for fish							
8440.20		20	36,7	3	5	12	0,78
8440.24		24	43,5	3,5	5	14	1,03
8440.28		28	50	3,8	5	18	1,31
8440.32		32	55,6	4,5	5	20	1,7

The traditional non-stick frypan CHOC made of thick aluminium is equipped with a heat resistant coloured cast strip handle. Practical and hygienic, this new system avoids cross contamination (transfer of bacteria from one food to another). You simply cook different foods in different frypans. It is helpful in professional kitchens that must observe strong hygiene regulations.

**Pancake non-stick pan CHOC Resto Induction**



Code	Designation	Øcm	Th.mm	Bottom ø cm	Kg
8485.26		26	4	18	0,8
8485.30		30	4	22	1



**Fish oval non-stick frypan CHOC Resto Induction**



Code	Designation	Lcm	Wcm	Hcm	Th.mm	Bottom ø cm	Kg
8481.36		36	26	4,3	5	18	1,7

This non-stick frying pan is ideal for cooking delicate dishes such as fish. The oval shape of this frying pan enables whole fish to be cooked. Firmly riveted steel handle.





**PROFESSIONAL PANS MADE OF THICK ALUMINIUM  
NON STICK : high-quality 5-layer PTFE coating**

Improved resistance to abrasion Grooved bottom for better heat spreading and cooking Firmly riveted strip steel handle

All heat sources except induction.

Oven cooking : 200°C during 10 minutes

*For simmering, reheating and cooking delicate dishes*

**CHOC  
CLASSIC**



**Round frypan CHOC**



Code	Designation	Øcm	Lcm	Hcm	Th.mm	Kg	PU
8180.20		20	36,7	3	4	0,61	3
8180.24		24	43,5	3,5	4	0,83	3
8180.26		26	48	3,7	4	0,95	3
8180.28		28	50	3,8	4	1,03	3
8180.30		30	54	4,5	4	1,21	3
8180.32		32	55,6	4,5	4	1,31	3
8180.36		36	66	4,7	5	2,03	3
8180.40		40	70	5,3	5	2,36	3

The non-stick frying pan is ideal for re-warming, for readying pre-cooked dishes for serving, and for cooking delicate dishes. This "lyonnaise" profile frying pan has a high flared and curved skirt. This very distinctive shape, with no sharp angles, enables the food to slide easily from the frying pan onto a plate or dish. The strip steel handle is firmly riveted.

**Fish frypans CHOC**



Code	Designation	Lcm	Wcm	Hcm	Th.mm	Kg	PU
8181.36	Oval fish frypan	36	26	4,3	5	1,61	3
8181.40	Oval fish frypan	40	28	4,5	5	1,95	3
8184.38	Rectangular frypan	38	26	4,2	5	1,87	3

Oval and oblong frying pans are the ideal shape for cooking whole fish. The non-stick frying pan is ideal for cooking delicate dishes, such as fish. The strip steel handle is firmly riveted.

**Pancake pan CHOC**



Code	Designation	Øcm	Lcm	Hcm	Th.mm	Kg	PU
8185.22		22	42	1,5	3,3	0,6	5
8185.26		26	45	1,5	3,3	0,7	5
8185.30		30	54	1,5	3,3	0,8	5

The non-stick crepe pan has a low skirt and optimum slip qualities, allowing crepes to be easily turned and to slide onto a plate without any problem. Firmly riveted strip steel handle.

**Blinis pan CHOC**



Code	Designation	Øcm	Lcm	Hcm	Th.mm	Kg	PU
8140.12		12	24,2	1,5	3,3	0,2	10
8140.14		14	26	1,7	4	0,24	10

These frying pans allow you to make the well known Russian specialty, blinis as well as fritters and pancakes. The strip steel handle is riveted.

**Non-stick conical sauté-pan CHOC**



Code	Designation	Øcm	Lcm	Hcm	Th.mm	Kg
8188.24		24	43	6,5	4	1,2
8188.28		28	49,5	7,1	4	1,27

The curved sauté pan is ideal for boiling down foods as its small base enables rapid heating and its large rim diameter allows a high degree of evaporation while stirring the contents. Pouring rim and rounded angles.

**Roasting pan, 2 handles - Thick aluminium**



Code	Designation	Lcm	Wcm	Hcm	Th.mm	Kg
7664.30	Total length : 36 cm	30	30	6,5	4	1,9
7664.35	Total length : 41 cm	35	25	6,5	4	1,81
7664.40	Total length : 46 cm	40	32	8	4	2,6
7664.50	Total length : 56 cm	50	40	8	4	6,61

Useful for cooking, browning meat or serving.



**NON STICK PROFESSIONAL CHOC FRYPAN**  
**THICK GAUGE ALUMINIUM**  
 Multi-coated PTFE covering

**Riveted extra-strong handle with coloured coating :**

- Food safety
- Keeps each food taste separate

Riveted steel handle: possible oven cooking 10 minutes / 200°C

**CHOC CLASSIC**



**Round non-stick aluminium frypan CHOC with red handle**



Code	Designation	Øcm	Hcm	Th.mm	Kg	PU
Red handle for red meat						
8050.20		20	3	4	0,6	3
8050.24		24	3,5	4	0,9	3
8050.28		28	4	4	1,1	3
8050.32		32	4,5	4	1,6	3

The traditional non-stick frypan CHOC made of thick aluminium is equipped with a heat resistant coloured cast strip handle. Practical and hygienic, this new system avoids cross contamination (transfer of bacteria from one food to another). You simply cook

different foods in different frypans. It is helpful in professional kitchens that must observe strong hygiene regulations.

**Round non-stick aluminium frypan CHOC with yellow handle**



Code	Designation	Øcm	Hcm	Th.mm	Kg	PU
Yellow handle for white meat						
8070.20		20	3	4	0,6	3
8070.24		24	3,5	4	0,9	3
8070.28		28	4	4	1,1	3
8070.32		32	4,5	4	1,6	3

The traditional non-stick frypan CHOC made of thick aluminium is equipped with a heat resistant coloured cast strip handle. Practical and hygienic, this new system avoids cross contamination (transfer of bacteria from one food to another). You simply cook

different foods in different frypans. It is helpful in professional kitchens that must observe strong hygiene regulations.

**Round non-stick aluminium frypan CHOC with blue handle**



Code	Designation	Øcm	Hcm	Th.mm	Kg	PU
Blue handle for fish						
8040.20		20	3	4	0,6	3
8040.24		24	3,5	4	0,9	3
8040.28		28	4	4	1,1	3
8040.32		32	4,5	4	1,6	3

The traditional non-stick frypan CHOC made of thick aluminium is equipped with a heat resistant coloured cast strip handle. Practical and hygienic, this new system avoids cross contamination (transfer of bacteria from one food to another). You simply cook

different foods in different frypans. It is helpful in professional kitchens that must observe strong hygiene regulations.

**Round non-stick aluminium frypan CHOC with green handle**



Code	Designation	Øcm	Hcm	Th.mm	Kg	PU
Green handle for vegetables						
8060.20		20	3	4	0,6	3
8060.24		24	3,5	4	0,9	3
8060.28		28	4	4	1,1	3
8060.32		32	4,5	4	1,6	3

The traditional non-stick frypan CHOC made of thick aluminium is equipped with a heat resistant coloured cast strip handle. Practical and hygienic, this new system avoids cross contamination (transfer of bacteria from one food to another). You simply cook

different foods in different frypans. It is helpful in professional kitchens that must observe strong hygiene regulations.







ALUMINIUM NON-STICK FRYPAN  
SEMI-PROFESSIONAL

High quality PTFE non-stick coating  
All heat sources except induction

Riveted steel handle:  
possible oven cooking 10 minutes / 200°C

CHOC  
ACCESS

## Round frypan CHOC Access



Code	Designation	Øcm	Lcm	Hcm	Th.mm	Kg	PU
8030.20		20	37	3	3	0,47	3
8030.24		24	43,3	3,5	3,3	0,73	3
8030.28		28	49,5	4	3,3	0,93	3
8030.32		32	55,5	4,5	3,3	1,17	3
8030.36		36	65	4,5	4	1,66	3
8030.40		40	70	5,2	4	2,05	3

The non-stick CHOC Access frying pan enables rapid heating; it has a quality CHOC PTFE coating, thus ensuring optimum non-stick and slip qualities. It benefits from all the advantages of the "lyonnaise" profile. Its handle is firmly riveted.

## Spatula for non-stick frypans



Code	Designation	Lcm	Wcm	Kg	PU
4813.01N		28	6,5	0,03	5

This flexible nylon spatula has rounded edges and is recommended for use with CHOC cooking utensils as it avoids damaging their non-stick coating. Heat resistant.

## Box of 10 neoprene handle gloves for thermic protection



Code	Designation	Lcm	Wcm	Hcm	Kg
4636.00		20,5	13	5,5	0,26

## Universal stainless steel lid, for frying pans

new  
2023

Code	Designation	Øcm	Th.mm	Kg
3460.02	Suitable for frypans ø 20 - 24 cm	25	0,8	0,35
3460.03	Suitable for frypans ø 26 - 28 cm	29	0,8	0,45
3460.04	Suitable for frypans ø 30 - 32 cm	34	0,8	0,61

Stronger design for stability.  
Sturdy without being heavy.  
De Buyer stainless steel knob: easy to grab and place upside down.  
Non-flat surface: limits excess water on kitchen countertop.  
Gloss polish finish.  
Made in France.







# STAINLESS STEEL: A CLASSIC

Our stainless-steel products are must-have utensils for any kitchen. Its safe and durable stainless steel makes it easy to maintain. It's "pure gold". The AFFINITY multi-layer range is worth a special mention: the products heat up quickly and distribute heat beautifully.

st/steel  
cookware

---

- 56 -

Multilayer stainless steel material 5 layers  
**AFFINITY**

- 60 -

Multilayer stainless steel material 3 layers  
**ALCHIMY**

- 64 -





Stainless steel with sandwich bottom  
**MILADY**

- 66 -

Stainless steel with sandwich bottom  
**PRIM'APPETY**

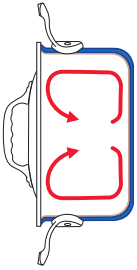
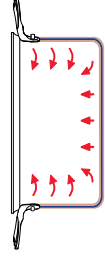
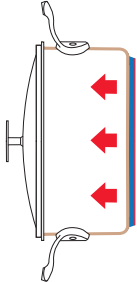
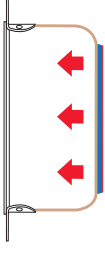
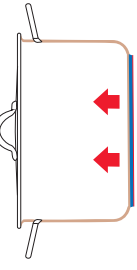

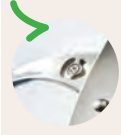
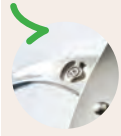
# STAINLESS STEEL RANGE

MULTILAYERS		SANDWICH BASES		
5-ply AFFINITY	3-ply ALCHIMY	MILADY	MILADY TWISTY	PRIM'APPETTY
				
2,3 to 2,7 mm	2,3 to 2,7 mm	0,6 to 0,8 mm	0,6 to 0,8 mm	0,8 to 1 mm
Cooking methods Browning / Blanching / Frying				
Designed for cooking 				
Finish Shiny polish	Brushed polish	Shiny polish		
Heat sources 				
Base of the utensil Multi-layer	Multi-layer	Thick sandwich base (7 mm)		
French-style curved handle Cast stainless steel handle	Sealed stainless steel tubing handle	Cast stainless steel handle		
Fixing of the handle or base Riveted		Bakelite removable handle		
Heat stop 				
Use in the oven 				
Dishwasher cleaning				
Pouring edge ✓	✓	✓		
Diameter (cm) 9 to 32	14 to 32	14 to 28		
PCB (packaging unit) 1	1	1		
		Spot welded		
		Sandwich base diffuser (4 to 7 mm)		
		Stainless steel tubing handle		
		Brushed polish		
		12 to 50		



# SIRH/+ BOCUSE D'OR

2023 FINAL PREMIUM PARTNER

In 2022, de Buyer is partnering with the Bocuse d'Or and is providing all the participants with products from the Affinity range.

Our company has also been supporting and assisting Team France since 2019.

Here, Chef Naïs Pirollet, winner of the Bocuse d'Or France, who will represent France at the World Final of the Bocuse d'Or in 2023.





COOKWARE AFFINITY

Innovative heat conductor multilayer stainless steel alloy - 5 layers:

- HOMOGENEOUS COOKING
- PERFECT HEAT DISTRIBUTION IN THE PAN
- SAVING VITAMINES AND ENERGY QUICK HEAT INCREASE

Gloss finish

Riveted handles made of cast stainless steel.

One-piece construction - Do not distort.

Thickness from 2,3 to 2,7 m

Suitable for all heat sources and oven cooking.

Made in France

# AFFINITY



Saucepan Affinity



Code	Designation	Øcm	Hcm	Liters.	Th.mm	Bottom ø cm	Kg
WITHOUT LID							
3706.14		14	7	0,9	2,3	12	0,73
3706.16		16	8	1,3	2,3	13	0,95
3706.18		18	9	1,8	2,3	15,6	1,12
3706.20		20	10	2,5	2,3	17	1,38
3706.24		24	13	4,1	2,3	20,5	2,4
WITH LID							
3746.16		16	8	1,3	2,3	13	0,91
3746.18		18	9	1,8	2,3	15,6	1,32
3746.20		20	10	2,5	2,3	17	1,38

Innovative heat conductor multilayer stainless steel alloy :

- QUICK HEAT INCREASE
- SAVING VITAMINES AND ENERGY
- PERFECT HEAT DISTRIBUTION IN THE PAN
- HOMOGENEOUS COOKING

Suitable for all heat sources and oven cooking.

- One-piece construction - Do not distort.
- Riveted handles made of cast stainless steel.
- L. Usable liters (75% of total capacity)

Set of 3 saucepans Affinity

Code	Designation	Th.mm	Kg
3706.01	Set of 3 saucepans ø16/18/20 cm	2,3	3,5







**Straight sauté-pan Affinity**



Code	Designation	Øcm	Hcm	Liters.	Th.mm	Bottom ø cm	Kg
3730.16		16	6	0,75	2,3		0,85
3730.20		20	6,5	1,6	2,3	17	1,16
3730.24		24	7	2,4	2,7	20,5	1,54
3730.28		28	7,5	3,8	2,7		2

This straight-rimmed sauté-pan is perfect for quickly browning food. Its shape assures that the humidity produced will evaporate quickly and that the juices will caramelize thoroughly.

**Rounded sauté-pan Affinity**



Code	Designation	Øcm	Hcm	Liters.	Th.mm	Bottom ø cm	Kg
3736.20		20	6,5	1,4	2,3	13	0,92
3736.24		24	7	2,1	2,3	17	1,34

This is the essential tool for boiling and reducing sauces. A base that is small in diameter for prompt heating and a wide rim for proper evaporation of the humidity produced. Thanks to this vessel, you will be able to prepare unsurpassable sauces.

**Non-stick frypan Affinity**



**Stainless steel frypan Affinity**



Code	Designation	Øcm	Lcm	Hcm	Th.mm	Bottom ø cm	Kg
3718.20		20	35,3	3	2,7	14	0,71
3718.24		24	42	3,5	2,7	17	1,1
3718.28		28	48	4	2,7	20	1,35
3718.32		32	55,4	4,5	2,7	23	1,72

This non-stick frying pan is ideal and allows delicate dishes like fish to be prepared with perfection. It is covered with PTFE and has a solid bottom that resists abrasion.

Code	Designation	Øcm	Hcm	Th.mm	Bottom ø cm	Kg
3724.20		20	4	2,7	14	0,69
3724.24		24	4	2,7	17	1,1
3724.28		28	4,5	2,7	20	1,34
3724.32		32	5	2,7	23	1,71

This totally stainless steel Affinity frying pan is ideal for quickly frying and grilling meat, thanks to its ability to rapidly increase in temperature. The quality of stainless steel

used to construct this frying pan qualifies it as a strong ally in the quest to caramelize your meat.

Wok Affinity with 2 cast st/steel riveted handles

Code	Designation	Øcm	Lcm	Hcm	Liters.	Th.mm	Perso	Kg
3743.32	Ø bottom 10 cm	32		12	4,1	2,7	9,5	1,9
3329.10	Grid for wok Ø 32 cm		34,5					0,14
Glass lid suitable for wok Affinity : Glass lid with stainless steel handle								
3428.32		32						1,19



For all hotplates including induction hobs

Sauté-pan with lid Affinity



Rounded sauté pan Affinity with st/steel handles and lid



Code	Designation	Øcm	Hcm	Liters.	Th.mm	Bottom Ø cm	Kg
3741.20		20	6,3	1,6	2,3		1,15
3741.24		24	7	2,4	2,7	20,5	1,98
3741.28		28	7,5	3,8	2,7		2

This vessel has the same qualities as the straight-rimmed sauté-pan, but its two handles make it even easier to use and equally less cumbersome. It will easily find its place in your kitchen.  
L. Usable liters (75% of total capacity)

Code	Designation	Øcm	Hcm	Liters.	Bottom Ø cm	Kg
3745.28		28	10	3,6	20,5	2,45

Stewpan with lid Affinity



Code	Designation	Øcm	Hcm	Liters.	Th.mm	Bottom Ø cm	Kg
3742.16		16	9	1,3	2,3	13	1,01
3742.20		20	11	2,5	2,3	17	1,7
3742.24		24	13	4,1	2,3	20,5	2,33
3742.28		28	15	6,6	2,7	24	3,64

Contrary to other kitchenware, this stewpan conserves humidity thanks to its high sides. Therefore, it is suitable for heating large quantities of water, simmering, etc. The Affinity material guarantees a rapid increase in temperature and therefore saves you a significant amount of time.

Stainless steel steamcooker



Code	Designation	Øcm	Kg
3675.24		24	0,66

Steaming is a quick operation with vegetables glisten, plunge them into cold water once they are cooked.  
Tip from the chef: to make your





Oval stewpan Affinity with lid



Code	Designation	Lcm	Wcm	Hcm	Liters.	Th.mm	Kg
3726.30	While stocks last	30	22	13	6,5	2,3	3,6

Stainless steel lid



Code	Designation	Øcm	Th.mm	Kg
3709.14N		14	1	0,24
3709.16N		16	1	0,28
3709.18N		18	1	0,33
3709.20N		20	1	0,39
3709.24N		24	1	0,51
3709.28		28	1	0,65

This Affinity lid is made to fit all kitchenware in this range, except round frypans.

Roasting-pan Affinity with 2 riveted cast st/steel handles



Code	Designation	Lcm	Wcm	Hcm	Th.mm	Kg
3727.35		41	27,5	8	2,3	2,3

Multilayer material : st/steel Aluminium St/steel

Brushed st/steel finish  
Suitable also for domestic oven.



COOKWARE ALCHIMY

Thick multi-layer stainless steel cookware 3 layers

Durable, robust, professional-quality product

Conducting material: responsive and economical on all heat sources

- Controlled cooking
- Energy savings
- Even cooking

Firm, reassuring feel

Hard-wearing, non-deformable stainless steel handles

French-style closed, watertight stainless steel tube handle

Handles solidly attached with rivets

Easy to use

Pouring edge and inside graduations

All heat sources + INDUCTION and oven

Brush polished

Made in France

ALCHIMY



Pan set Alchimy



Code	Designation	Lcm	Wcm	Hcm	Kg
Delivered in decorated box					
3601.03	Set 3 saucepans ø 16-18-20 cm	42	22,5	18,5	3,55
3601.06	Set 6 pcs : a saucepan ø16 cm / 2 stewpans ø 20-24 cm 3 stainless steel lids ø 16- 20-24 cm	47	29,5		3,33
3601.08	Set 8 pcs : 2 saucepans ø 16-20 cm / 1 rounded pan ø 16 cm / 1 stewpan ø 24 cm / 1 frypan ø 24 cm / 3 glass lids ø 16-20-24 cm	50,5	31,5	22,5	7,3

Saucepan Alchimy



Code	Designation	Øcm	Liters.	Th.mm	Kg
3601.14		14	0,9	2,3	0,7
3601.16		16	1,3	2,3	0,85
3601.18		18	1,8	2,3	1,03
3601.20		20	2,5	2,3	1,21
3601.24		24	4,1	2,3	1,66







**Straight sauté-pan Alchimy**

Code	Designation	Øcm	Hcm	Liters.	Th.mm	Kg
3602.24		24	7,7	2,3	2,3	1,15
3602.28		28	8,6	3,8	2,7	1,72



This straight-rimmed sauté-pan is perfect for quickly browning food. Its shape assures that the humidity produced will evaporate quickly and that the juices will caramelize thoroughly.

**Rounded sauté-pan with handle Alchimy**

Code	Designation	Øcm	Liters.	Th.mm	Kg
3603.16		16	0,8	2,3	0,66
3603.20		20	1,4	2,3	0,86
3603.24		24	2,2	2,3	1,17



This is the essential tool for boiling and reducing sauces. A base that is small in diameter for prompt heating and a wide rim for proper evaporation of the humidity produced. Thanks to this vessel, you will be able to prepare unsurpassable sauces.

**Stainless steel frypan Alchimy**



Code	Designation	Øcm	Th.mm	Kg
3604.20		20	2,7	0,68
3604.24		24	2,7	0,94
3604.28		28	2,7	1,16
3604.32		32	2,7	1,44

This stainless steel frying pan is ideal for quickly frying and grilling meat, thanks to its ability to rapidly increase in temperature. The quality of stainless steel used to construct

this frying pan qualifies it as a strong ally in the quest to caramelize your meat.





### Stewpan without lid Alchimy

Code	Designation	Øcm	Liters.	Kg
3605.16		16	1,3	0,77
3605.20		20	2,5	1,12
3605.24		24	4,1	1,54
3605.28		28	6,6	2,19



Contrary to other kitchenware, this stewpan conserves humidity thanks to its high sides. Therefore, it is suitable for heating large quantities of water, simmering, etc.



### Stainless steel steamcooker



Code	Designation	Øcm	Kg
3675.24		24	0,66

Steaming is a quick operation with this stainless steel steamer. Fits to the pan of the stainless steel and copper cookware. Equipped with an handle to remove it easily.

Tip from the chef: to make your vegetables glisten, plunge them into cold water once they are cooked.



Wok Alchimy

Code	Designation	Øcm	Lcm	Liters.	Th.mm	Bottom ø cm	Kg
3608.32		32		4,1	2,7	16,5	1,53
3329.10	Grid for wok ø 32 cm		34,5				0,14



For all hotplates including induction hobs

Glass lid with stainless steel knob - compatible with Alchimy

new  
2023



Code	Designation	Øcm	Kg
3428.14		14	0,25
3428.16		16	0,31
3428.18		18	0,37
3428.20		20	0,44
3428.24		24	0,59
3428.28		28	0,93
3428.32		32	1,19

This lid with a deep stainless steel rim fits perfectly all cookware from the ALCHIMY collection, apart from the frying pans (see st/steel lid for frying pans, ref. 3460). Essential for slow cooking or keeping preparations warm

without drying. The stainless steel knob is easy to grab and can be used to place the lid upside down, flat on kitchen countertop. Oven safe.



Stainless steel lid

Code	Designation	Øcm	Kg
3509.14		14	0,13
3509.16		16	0,16
3509.18		18	0,18
3509.20		20	0,21
3509.24		24	0,3
3509.28		28	0,43
3509.32		32	0,66



Suitable for all range products, except on frypans.

Alchimy pans with removable handle are also available  
See page 74

STAINLESS STEEL COOKWARE MILADY  
PRO QUALITY

Ergonomic riveted handle made of cast stainless steel  
= good hand grip without tiredness  
Large thick magnetic bottom  
All heat sources + induction  
Perfect heat spreading on the whole bottom  
Gloss polished

MILADY



Stainless steel stewpan MILADY with glass lid



Code	Designation	Øcm	Hcm	Liters.	Th.mm	Bottom ø cm	Kg
3427.20	Stewpan with glass lid	20	10	3	0,8	17,8	1,7
3427.24	Stewpan with glass lid	24	12	5,4	0,8	19,5	2,19
3427.28	Stewpan with glass lid	28	14	8	0,8	25	2,86

The range MILADY is extending with this elegant stainless steel stewpan. It is equipped with 2 large ergonomic st/steel handles and a glass lid.

Stainless steel steamcooker



Code	Designation	Øcm	Kg
3675.24		24	0,66

Steaming is a quick operation with this stainless steel steamer. Fits to the pan of the stainless steel and copper cookware. Equipped with an handle to remove it easily.  
Tip from the chef: to make your vegetables glisten, plunge them into cold water once they are cooked.



**Stainless steel frypan MILADY with riveted cast st/steel handle**



Code	Designation	Øcm	Hcm	Liters.	Th.mm	Bottom ø cm	Kg
3412.24		24	4,8	1,2	0,8	17,5	1,24
3412.28		28	5,3	1,8	0,8	21	1,64

**Stainless steel saucepan MILADY with riveted cast st/steel handle**



Code	Designation	Øcm	Hcm	Liters.	Th.mm	Bottom ø cm	Kg
3410.14		14	7	1,2	0,8	12	0,64
3410.16		16	8	1,6	0,8	14	0,7
3410.18		18	9	2,2	0,8	15,8	0,89
3410.20		20	10	3	0,8	17,8	1,1
3410.03	Set of 3 saucepans ø 16-18-20 cm						3,15
3410.04	Set of 4 saucepans ø 14-16-18-20 cm				0,8		3,83



Discover the 'Milady de Buyer', a new pro quality stainless steel cookware which is assembled with a new cast st/steel riveted handle. Designed by de Buyer, this handle brings design along with ergonomomy and solidity. Saucepans and

frypans of the range are equipped with a magnetic bottom which allows a perfect heat spreading on all heat sources.

**Stainless steel sauté-pan MILADY with riveted cast st/steel handle**



Code	Designation	Øcm	Hcm	Liters.	Th.mm	Bottom ø cm	Kg
3411.24		24	8	3	0,8	17,7	1,1

**Glass lid with stainless steel knob**



Code	Designation	Øcm	Kg
3429.14		14	0,24
3429.16		16	0,29
3429.18		18	0,35
3429.20		20	0,41
3429.24		24	0,58
3429.28		28	0,74

These glass lids with stainless steel button fit the MILADY range of pans and sauté pans (not for round frypans). Suitable for oven cooking.



# PRIM'APPETY

## STAINLESS STEEL COOKWARE PRIM'APPETY PROFESSIONAL Stainless steel - Satin polished

Magnetic sandwich bottom - For all heat sources + INDUCTION  
Welded handles - Easy cleaning - Dishwasher safe



### Saucepan Prim'Appety



Code	Designation	Øcm	Hcm	Liters.	Th.mm	Kg
3501.04	Set of 4 saucepans ø 14-16-18-20 cm				0,8	3,3
3501.12		12	6	0,7	0,8	0,44
3501.14		14	7	1	0,8	0,6
3501.16		16	7,5	1,6	0,8	0,7
3501.18		18	9	2,2	0,8	0,9
3501.20		20	9	3	0,8	1,07
3501.24		24	11	5,4	0,8	1,55
3501.28	with 2 handles	28	13	8	0,8	2,4

Totally stainless steel. Sandwich bottom. Pouring lips. All heat sources including induction. Easy to clean. Satin polished. Welded handles.

### Round stainless steel frypan Prim'Appety



Code	Designation	Øcm	Hcm	Th.mm	Kg
3504.20		20	5	0,6	1,12
3504.24		24	5	0,6	1,35
3504.28		28	5	0,8	1,45
3504.32	With 2 handles	32	6,5	0,8	2,5





Rounded sauté-pan Prim'Appety

Sauté-pan Prim'Appety , st. steel handle



Code	Designation	Øcm	Hcm	Th.mm	Kg
3503.16		16	6	0,8	0,65
3503.18		18	6,5	0,8	0,85
3503.20		20	7	0,8	1,1
3503.24		24	8	0,8	1,3
3503.28		28	10	0,8	1,5

Code	Designation	Øcm	Hcm	Th.mm	Kg
3502.20		20	6	0,8	1
3502.24		24	6	0,8	1,2
3502.28		28	6	0,8	1,4

Stewpan without lid Prim'Appety

Code	Designation	Øcm	Hcm	Liters.	Th.mm	Kg
3505.20		20	10	3,1	0,8	1,16
3505.24		24	12	5,4	0,8	1,66
3505.28		28	14	8,6	0,8	2,13
3505.32		32	16	13,5	0,8	3,2
3505.36		36	18	18,3	0,8	4
3505.40		40	20	25	1	5,7
3505.45		45	22,5	33	1	7,6
3505.50		50	25	43,4	1	8,9



Totally stainless steel. Thick sandwich bottom. Pouring lips.  
Satin polished. Welded handles.  
All heat sources including induction. Easy to clean.



## High stewpan Prim'Appety without lid



Code	Designation	Øcm	Hcm	Liters.	Th.mm	Kg
3506.20		20	13	4	0,8	1,26
3506.24		24	14,5	6,6	0,8	1,8
3506.28		28	18	11,1	0,8	2,3
3506.32		32	20	16,1	0,8	3,8
3506.36		36	22	22,4	0,8	4,5
3506.40		40	25	31,4	1	6
3506.50		50	30	58,9	1	9,2

## Stockpot without lid Prim'Appety



Code	Designation	Øcm	Hcm	Liters.	Th.mm	Kg
3507.20		20	20	6,25	0,8	1,7
3507.24		24	24	11	0,8	2,1
3507.28		28	28	17	0,8	2,9
3507.32		32	32	25	0,8	4,4
3507.36		36	36	36	0,8	5,1
3507.40		40	40	45	1	6,4
3507.45		45	45	69	1	9
3507.50		50	50	100	1	11

Totally stainless steel. Sandwich bottom. Pouring lips. All heat sources including induction. Easy to clean. Satin polished. Welded handles.

## Stainless steel steamcooker



Code	Designation	Øcm	Kg
3675.24		24	0,66

Steaming is a quick operation with this steamer. Suitable for PRIM'APPETY stewpans. Tip from the chef: to make your vegetables glisten, plunge them into cold water once they are cooked.

## Stainless steel lid



Code	Designation	Øcm	Kg
3509.14		14	0,13
3509.16		16	0,16
3509.18		18	0,18
3509.20		20	0,21
3509.24		24	0,3
3509.28		28	0,43
3509.32		32	0,66
3509.36		36	0,8
3509.40		40	0,96
3509.45		45	1,12
3509.50		50	1,8

Suitable for all range products



**Stainless steel rounded WOK - Special induction hob**



Code	Designation	Øcm	Lcm	Hcm	Th.mm	Kg
3122.36	Flat rim Inner pan: polished Outer pa : gloss polished	36	63,5	9,5	1,5	1,3

Typical Asian rounded form adapted to the wok induction cooker. Enables to seal and cook food with little fat for a dietetic and natural Asian cuisine. Optimized weight of the wok to cook effortlessly. Thanks to the thickness of 15/10° the wok is both solid

and light. The cold ergonomic riveted handle made of stainless steel allows optimum grip without tiredness.

**Stainless steel stand for hemispherical wok**



Code	Designation	Øcm	Hcm	Th.mm	Kg
3122.00		24	3,65	1	0,25

Suitable for rounded woks 3122.90 and 5114.35. Enables to use these woks on standard flat induction hotplates. Thanks of the special form with its handle support, the wok is steady on the plate.

**Bain-marie without lid**



Code	Designation	Øcm	Hcm	Liters.	Th.mm	Kg
3111.12		12	11,5	1,3	0,8	0,42
3111.14		14	14	2,1	0,8	0,51
3111.16		16	16	3,2	0,8	0,73
3111.18		18	18	4,6	0,8	0,86

The bain-marie cooking pot is made from stainless steel. Its shape means it can be placed inside a water container (pan), and it allows milk, chocolate, sauces, etc., to be cooked using the bain-marie process. The lid is sold separately

**Food storage canister, without lid**



Code	Designation	Øcm	Hcm	Liters.	Th.mm	Kg
3390.14		14	12	1,7	0,8	0,49
3390.16		16	13	2,5	0,8	0,59
3390.20		20	16,5	5	0,8	0,91
3390.24		24	20	8	0,8	1,28

This stainless steel canister with cupped handles allows food to be stored in perfect safety. It can be used as a container for warming food using the bain-marie process.

**Bain-marie cooker**



The double boiler cooker consists of a hollow stainless steel shell in which water is heated. It enables to heat at lukewarm temperatures. No burning, no sticking, no boiling over.

- Examples of uses :
- Melting chocolate.
  - Preparing sauces or creams.
  - Maintaining temperature of preparations.
  - Reheating dishes.
  - Heating milk etc.

Suitable on all heat sources incl. induction hobs.

Code	Designation	Øcm	Hcm	Liters.	Th.mm	Kg
3437.16N	With handle and double st. steel body	16	12,5	1,5	1	0,97







# cookware REMOVABLE LINE

Cook, simmer or sear,  
Stainless steel, carbon steel or nonstick  
Customizable and space saving cookware without any compromise.  
Three materials with a variety of cookware styles and comfortable  
and ergonomic handles to choose from.

- 77 -

## REMOVABLE LINE STAINLESS STEEL & WOODEN HANDLES

Multilayer stainless steel  
ALCHIMY

Nonstick  
CHOC EXTREME

Carbon steel MINERAL B

- 78 -

## REMOVABLE LINE BAKELITE & SILICONE HANDLES

Stainless steel with sandwich bottom  
MILADY

Nonstick  
CHOC INTENSE

Carbon steel MINERAL B



# REMOVABLE LINES

## REMOVABLE LINE STAINLESS STEEL & WOODEN HANDLES



### LOQY



#### Removable handles

Long handle

Cast stainless steel. Sturdy & durable. Curved French-style handle for an optimal grip. Can be held firmly and safely with one hand. Locks automatically by placing the handle straight down. Press button to unlock.



Handles

Beechwood and stainless steel rivets. Sold in pack of 2. Handles securely clip on bases. Made in France.

## REMOVABLE LINE BAKELITE & SILICONE HANDLES



### TWISTY



Removable Bakelite handle. Comes in 4 colors. Non-slip, velvety feel. Ergonomic. Heat resistant. Can be held firmly and safely with one hand. Locks and unlocks with a simple rotation.

Silicone. Sold in pack of 2. Handles securely clip on bases.

#### Collections

**ALCHEMY**

Multilayer stainless steel  
3 layers

Finish

Brushed  
x 2 riveted

Cooking methods

Browning, Blanching, Frying.

Heat sources



Oven cooking without handles



Dishwasher



**CHOC EXTREME**

Cast aluminium

Nonstick coating  
extra long lasting resistance

x 2 riveted

Reheating, Simmering, Cooking gently.

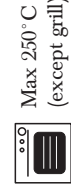

Occasional not to alter the nonstick coating

4 saucepans  
2 sauté-pans  
2 round frypans

**MINERAL B**

Steel  
Thick white steel

Beeswax protection

x 2 riveted

Searing, Grilling, Browning.



2 round frypans

**MILADY**

Stainless steel  
sandwich base 7 mm

Shiny

x 2 welded

Browning, Blanching, Frying.



6 saucepans  
1 conical sauté-pan  
2 round frypans

**CHOC INTENSE**

Forged aluminium

Nonstick coating  
long lasting resistance

x 1 riveted

Reheating, Simmering, Cooking gently.



Occasional not to alter the nonstick coating

2 conical sauté-pans  
4 round frypans  
2 crepe pans

**MINERAL B**

Steel  
Thick white steel

Beeswax protection

x 1 riveted

Searing, Grilling, Browning.



1 conical sauté-pan  
3 round frypans  
1 crepe pan



These iconic de Buyer collections also come with the option of removable handles:

- Stainless Steel ALCHIMY LOQY
- Non-stick CHOC EXTREME LOQY
- Carbon steel MINERAL B LOQY

Three cookware collections that complement each other for all-purpose cooking. Saucepans, stewpans, frying pans, saute pans: all the kitchen essentials made with a beautiful and ergonomic design fit for professionals.

With an innovative clamping system that is safe, simple and durable. Easy and safe handling with 2 bases firmly fastened with rivets.



Cast stainless steel handle for removable line LOQY

Set of 2 wooden handles for removable line LOQY

new 2023



new 2023



Code	Designation	Kg
3660.00		0,2

Cast stainless steel. Sturdy and durable. French-style curved handle, to provide optimal grip. Can be held firmly and safely with one hand. Locks automatically by placing the handle straight down. Press button to unlock.

Code	Designation	Kg
3660.02		0,04

Beechwood and stainless steel rivets. Sold in pack of 2. Handles securely clip on bases. Made in France.



**ALCHIMY COOKWARE**

**3ply multi-layer stainless steel cookware**

Durable, robust, professional-quality product  
 Conductive material: responsive and economical on all heat sources

- Temperature control
- Even heating
- Faster cooking

**Easy to use**

Pouring edge and inside measurement marks  
 All heat sources + INDUCTION and oven  
 Brushed finish

**Made in France**

# ALCHIMY



set 3661.03



**Multilayer stainless steel saucepan ALCHIMY , without handle**



Set 3661.02

Code	Designation	Øcm	Liters.	Th.mm	Kg
3661.16		16	1,3	2,3	0,74
3661.18		18	1,8	2,3	0,91
3661.20		20	2,5	2,3	1,09
3661.24		24	4,1	2,3	1,5
3661.02	2 saucepans ø16-20 cm + long handle 3660.00				2,1
3661.03	Set 3 saucepans ø 16-20-24 cm + set 2 handles 3660.02 + 3 glass lids 3428 ø 16-20-24 cm				5

See page 73 for removable handles (long handles 3660.00/double handles 3660.02), to be ordered separately. The lid ref. 3428 perfectly fits saucepans from the ALCHIMY collection.

**Stainless steel steamcooker**



Code	Designation	Øcm	Kg
3675.24		24	0,66

Steaming is quick and easy with this stainless steel steamer. Fits perfectly inside our various stainless steel and copper pans of the same size. Equipped with a handle to easily remove it.

**Chef's Tip:** make your vegetables glisten by plunging them into the cold water after cooking.







### Straight sauté-pan Alchimy without handle

new  
2023



Code	Designation	Øcm	Hcm	Liters.	Th.mm	Kg
3662.24		24	7,7	2,3	2,3	1,2
3662.28		28	8,6	3,8	2,7	1,57

Each model comes with 2 bases to clip handles on. Handles not included.

See page 73 for removable handles (long handles 3660.00/double handles 3660.02), to be ordered separately.

The lid ref. 3428 with its deep stainless steel rim perfectly fits all utensils from the ALCHIMY collection.

This straight-rimmed sauté-pan is perfect for quickly browning food. Its shape assures that the humidity produced will evaporate quickly and that the juices will caramelize thoroughly.

### Glass lid with stainless steel knob, compatible with Alchimy

new  
2023



Code	Designation	Øcm	Kg
3428.16		16	0,31
3428.18		18	0,37
3428.20		20	0,44
3428.24		24	0,59
3428.28		28	0,93

This lid with a deep stainless steel rim fits perfectly all cookware from the ALCHIMY collection, apart from the frying pans (see stainless steel lid for frying pans, ref. 3460).

Essential lid, ideal for slow cooking or keeping preparations warm without drying. The stainless steel knob is easy to grab and can be

used to place the lid upside down, flat on kitchen countertop. Oven safe.

### Stainless steel frypan Alchimy without handle

new  
2023



Code	Designation	Øcm	Th.mm	Bottom ø cm	Kg
3663.24		24	2,7	17	0,81
3663.28		28	2,7	20	1

Each model comes with 2 bases to clip handles on. Handles not included.

See page 73 for removable handles (long handles 3660.00/double handles 3660.02), to be ordered separately.

This stainless steel frying pan is ideal for quickly frying and grilling meat, thanks to its ability to rapidly increase in temperature. The quality of stainless steel used to construct this frying pan qualifies it as a strong ally in the quest to caramelize your meat.

### Universal stainless steel lid, for frying pans

new  
2023



Code	Designation	Øcm	Th.mm	Kg
3460.02	Suitable for frypans ø 20 - 24 cm	25	0,8	0,35
3460.03	Suitable for frypans ø 26 - 28 cm	29	0,8	0,45

Stronger design for stability.

Sturdy without being heavy.



CHOC EXTREME removable line

Cookware made of real pressure cast aluminium  
 Improved higher quality non-stick coating  
 ULTRA REINFORCED  
 Extreme durability = longer lifetime  
 Undistortable thick magnetic bottom  
 All heat sources including induction

*For simmering, reheating and cooking delicate dishes*

# CHOC EXTREME



Round nonstick frypan CHOC EXTREME without handle

**new  
2023**



Code	Designation	Øcm	Th.mm	Perso	Kg
8364.24		24	3	16,2	1
8364.28		28	3	18,5	1,28
Stainless steel universal lid for frypan:					
3460.02	Suitable for frypans ø 20 - 24 cm	25	0,8		0,35
3460.03	Suitable for frypans ø 26 - 28 cm	29	0,8		0,45

Each model comes with 2 bases to clip handles on. Handles not included.  
 See page 73 for removable handles (long handles 3660.00/double handles 3660.02), to be ordered separately.

CHOC EXTREME is made from pressure cast aluminium and is covered with the highest quality non-stick coating which is consolidated by a PTFE projection. It stands up excellently to deformation, scratches and sudden changes in temperature. This frying pan is ideal for providing regular cooking.



Non-stick sauté-pan CHOC EXTREME without handle

**new  
2023**



Code	Designation	Øcm	Liters.	Th.mm	Bottom ø cm	Kg
8365.24		24	2,5	3	14,6	1,2
8365.28		28	3,5	3	18,7	1,52
Glass lid with stainless steel handle						
3429.24		24				0,58
3429.28		28				0,74

Each model comes with 2 bases to clip handles on. Handles not included. See page 73 for removable handles (long handles 3660.00/double handles 3660.02), to be ordered separately.





**MINERAL B CARBON STEEL COOKWARE - BEESWAX FINISH  
REMOVABLE LINE**

# MINERAL B

- beeswax finish protects against oxidation
- natural nonstick coating
- seasoning required

All heat sources + induction  
Oven-safe without handles

Made in France  
ORIGINE FRANCE GARANTIE



**Steel frypan MINERAL B without handle**

**new  
2023**



Code	Designation	Øcm	Th.mm	Bottom ø cm	Kg
5664.24		24	2,5	17,5	1,26
5664.28		28	3	20,5	1,91

Each model comes with 2 bases to clip handles on. Handles not included.  
See page 73 for removable handles (long handles 3660.00/double handles 3660.02), to be ordered separately.

**Universal stainless steel lid, for frying pans**

**new  
2023**



Code	Designation	Øcm	Th.mm	Kg
3460.02	Suitable for frypans ø 20 - 24 cm	25	0,8	0,35
3460.03	Suitable for frypans ø 26 - 28 cm	29	0,8	0,45
3460.04	Suitable for frypans ø 30 - 32 cm	34	0,8	0,61

Stronger design for stability.  
Sturdy without being heavy.  
De Buyer stainless steel knob: easy to grab and place upside down.  
Non-flat surface: limits excess water on kitchen countertop.  
Gloss polish finish.





**TWISTY**



**STAINLESS STEEL COOKWARE TWISTY**  
Removable line

Large thick magnetic bottom INDUCTION - All heat sources + induction  
Perfect heat spreading on the whole bottom  
Gloss polished - Pouring lips & Rounded edges  
Perfect hygiene and easy cleaning

**Removable "Soft Touch" handle**



Code	Designation	Kg
8359.00	Black	0,12
8359.20	Green	0,12
8359.30	Orange	0,12
8359.40	Red	0,12

Removable Bakelite handle. Comes in 4 colors.  
Non-slip, velvety feel. Ergonomic. Heat resistant.  
Can be held firmly and safely with one hand.  
Locks and unlocks with a simple rotation.

This handle is suitable for the 3 removable cookware ranges :  
- Stainless steel TWISTY  
- Nonstick aluminium CHOC INTENSE  
- Steel MINERAL B

**Stainless steel saucepan TWISTY without handle**



Code	Designation	Øcm	Hcm	Liters.	Th.mm	Bottom ø cm	Kg
3491.14		14	7	1,2	0,8	12	0,44
3491.16		16	8	1,6	0,8	14	0,53
3491.18		18	9	2,2	0,8	15,8	0,72
3491.20		20	10	3	0,8	17,8	0,85
3491.24		24	12	5,4	0,8	19,5	1,28
3491.28	Use only with both silicone handles	28	14	8	0,8	25	1,95
3491.03	Set of 3 saucepans ø 16-18-20 cm without handles				0,8		2,49
3491.04	Set of 4 saucepans ø 14-16-18-20 cm supplied with an handle & 2 silicone handles - black				0,8		3,11





**Stainless steel steamcooker**



Code	Designation	Øcm	Kg
3675.24		24	0,66

Steaming is a quick operation with this stainless steel steamer. Fits to the pan of the stainless steel and copper cookware. Equipped with an handle to remove it easily.  
Tip from the chef: to make your vegetables glisten, plunge them into cold water once they are cooked.



**Stainless steel sauté-pan TWISTY**



**Stainless steel frypan TWISTY, without handle**



Code	Designation	Øcm	Hcm	Liters.	Th.mm	Bottom ø cm	Kg
3495.24		24	8	3	0,8	17,7	0,98

Code	Designation	Øcm	Hcm	Liters.	Th.mm	Bottom ø cm	Kg
3493.24		24	4,8	1,2	0,8	17,5	0,88
3493.28		28	5,3	1,8	0,8	21	1,22

**Glass lid**



Code	Designation	Øcm	Hcm	Kg
4112.14		14	6,3	0,24
4112.16		16	6,3	0,3
4112.18		18	6,3	0,35
4112.20		20	6,8	0,41
4112.24		24	7,5	0,58
4112.28		28	7,5	0,74

Possible oven cooking 200°C max.

**Set of 2 black silicone handles**



Code	Designation	Kg
8360.00	black	0,04



CHOC INTENSE Removable nonstick line - FORGED ALUMINIUM

NONSTICK COOKWARE

Removable Soft Touch comfortable and ergonomic handle  
 All heat sources + induction  
 Made in France

CHOC  
 INTENSE



Nonstick frypan CHOC INTENSE, without handle



Code	Designation	Øcm	Th.mm	Bottom ø cm	Kg
8740.20		20	4	14	0,6
8740.24		24	4	16,6	0,8
8740.28		28	4	20,6	1,1
8740.32		32	4	22	1,3

Nonstick sauté pan CHOC INTENSE, without handle

Code	Designation	Øcm	Bottom ø cm	Kg
8748.24		24	16,6	1
8748.28		28	22	1,3
	Glass lid, st/steel handle			
3429.24		24		0,58
3429.28		28		0,74



Nonstick crêpe pan CHOC INTENSE, without handle

Code	Designation	Øcm	Th.mm	Perso	Kg
8745.26		26	4	18	0,73
8745.30		30	4	22	1







**MINERAL B CARBON STEEL COOKWARE - BEESWAX FINISH**

**REMOVABLE LINE TWISTY**

- beeswax finish protects against oxidation
- natural nonstick coating
- seasoning required

Removable Soft Touch comfortable and ergonomic handle  
All heat sources + induction

Oven-safe without handles

Made in France

ORIGINE FRANCE GARANTIE

**Removable "Soft Touch" handle**

Code	Designation	Kg
8359.00	Black	0,12
8359.20	Green	0,12
8359.30	Orange	0,12
8359.40	Red	0,12



Removable Bakelite handle. Comes in 4 colors.  
Non-slip, velvety feel. Ergonomic. Heat resistant.  
Can be held firmly and safely with one hand.  
Locks and unlocks with a simple rotation.



**Steel frypan MINERAL B, without handle**



**Steel sauté pan MINERAL B, without handle**



Code	Designation	Øcm	Th.mm	Bottom ø cm	Kg
5630.20		20	2,5	14	0,86
5630.24		24	2,5	17,5	1,23
5630.28		28	3	21	1,93

Code	Designation	Øcm	Hcm	Liters	Th.mm	Bottom ø cm	Kg
5634.24		24	7,8	2,5	2,5	16,5	1,72
3429.24	Glass lid with stainless steel handle	24					0,58

**Steel crepe pan MINERAL B, without handle**



Code	Designation	Øcm	Hcm	Th.mm	Bottom ø cm	Kg
5635.26		26	1,3	2,5	22,5	1,24



de Buyer  
MADE IN FRANCE

de Buyer





# THE EXCELLENCE OF COPPER

Copper is a leading material for kitchen use and loved by professionals and keen amateurs as well. It conducts heat quickly and evenly and is perfect for thickening sauces and cooking when particular care is required. The utensil bodies are made of a colaminated material (90% copper; 10% stainless steel). The copper is hand-polished using traditional methods - its gentle, soothing aura making it the perfect companion for your table.

---

- 85 -

Copper stainless steel Induction  
**PRIMA MATERA**  
cast stainless steel handles

- 89 -

Copper stainless steel Induction  
**PRIMA MATERA**  
cast steel handles

- 91 -

Copper stainless steel INOCUIVRE  
cast stainless steel handles

- 94 -

Copper stainless steel INOCUIVRE  
cast steel handles

- 96 -

Copper stainless steel INOCUIVRE  
brass handles



INDUCTION  
PRIMA MATERA

SOLID COPPER

Material of the body of the pan  
90% copper outside and 10% stainless steel inside

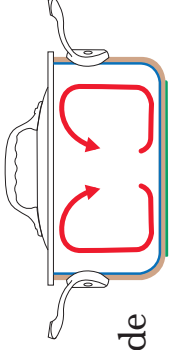

NON-INDUCTION  
INOCUIVRE

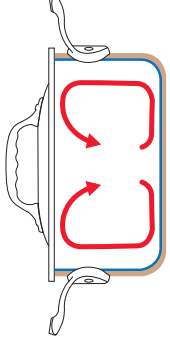

Thickness	2 mm	1,2 to 2 mm
Cooking methods	Simmering / Reducing / Flambéing	
Designed for cooking		
Finish	Shiny polish	
Heat sources		
Base of the utensil	Projected stainless steel base	
French-style curved type of handle	Cast stainless steel handle	Cast steel handle
Fixing of the handle or base	Riveted	
Heat stop		
Use in the oven		
Dishwasher cleaning		
Diameter (cm)	14 to 32	9 to 36
PCB (packaging unit)	1	1
		10 to 32
		1
		1



INOUCIVRE INDUCTION

- Copper outside 90% = excellent heat diffusion
- Stainless steel inside 10% = matchless hygiene - ease of use
- Ergonomic cast stainless steel riveted handles
- All heat sources including induction
- Made in France

# PRIMA MATERA



Saucepan with magnetic bottom INDUCTION



Code	Designation	Øcm	Hcm	Liters.	Th.mm	Bottom ø cm	Kg
6206.14		14	7,3	1,2	2	12	1,06
6206.16		16	8,3	1,8	2	13,5	1,37
6206.18		18	9,3	2,5	2	15,5	1,66
6206.20		20	10,5	3,3	2	17	2,06
6206.24		24	12,4	6	2	22	2,75

This saucepan made of copper and stainless steel on the inside enables to enjoy the exceptional degree of conductivity of copper on all types of heat sources, including INDUCTION, thanks to its magnetic bottom. The cast stainless steel ergonomic handle are firmly riveted. The st/steel lid 3709 is suitable for the PRIMA MATERA pans (except frypan).

Sauté pan with magnetic bottom INDUCTION



Code	Designation	Øcm	Hcm	Liters.	Th.mm	Bottom ø cm	Kg
6230.16		16	5,5	1	2	13,5	1,13
6230.20		20	5,8	1,8	2	17,5	1,48
6230.24		24	6,6	3	2	22	2,06

The st/steel lid 3709 is suitable for the PRIMA MATERA pans (except frypan).



**Frypan with magnetic bottom INDUCTION and stainless steel handle**

Code	Designation	Øcm	Hcm	Th.mm	Bottom ø cm	Kg
6224.20		20	4	2	13,5	1,3
6224.24		24	4	2	16,5	1,41
6224.28		28	4	2	20	1,86
6224.32		32	5,5	2	23	2,38



**Conical sauté pan with magnetic bottom INDUCTION**

Code	Designation	Øcm	Hcm	Liters.	Th.mm	Bottom ø cm	Kg
6236.20		20	7,2	1,7	2	13	1,32
6236.24		24	8,2	3,1	2	16,3	2,75



This flared sauté pan is ideal for boiling down cooking juices. That's often one of the reasons it's the professionals' first choice. The st/steel lid 3709 is suitable for the PRIMA MATERA pans (except frypan).

**Stainless steel lid**



Code	Designation	Øcm	Th.mm	Kg
3709.14N		14	1	0,24
3709.16N		16	1	0,28
3709.18N		18	1	0,33
3709.20N		20	1	0,39
3709.24N		24	1	0,51
3709.28		28	1	0,65

This lid is made to fit all kitchenware in this range, except round frypans.





**Stockpot with magnetic bottom INDUCTION and st/steel lid**



Code	Designation	Øcm	Hcm	Liters.	Th.mm	Bottom ø cm	Kg
6244.20		20	18	5,7	2	22	3,1

This stockpot is a must for simmering family dishes and is the ideal utensil for preparing bouillabaisse, Irish stew, couscous ingredients, vegetable broth, etc.

**High stewpan with magnetic bottom INDUCTION and st/steel lid**



Code	Designation	Øcm	Hcm	Liters.	Th.mm	Bottom ø cm	Kg
6243.24		24	16,5	7,5	2	22	3,6



**Sauté pan and st/steel lid**



**Rounded sauté pan with 2 st/steel handles**



Code	Designation	Øcm	Hcm	Liters.	Th.mm	Bottom ø cm	Kg
6241.20		20	6	1,8	2	17,5	1,9
6241.24		24	6,8	3,1	2	22	2,51
6241.28		28	9,2	4,9	2	25	3,12

Code	Designation	Øcm	Hcm	Liters.	Th.mm	Bottom ø cm	Kg
6232.28	delivered with stainless steel lid	28	10	4,9	2	20,5	3,12

This sauté pan made of copper and stainless steel on the inside has a magnetic bottom and is adapted to all hotplates, including INDUCTION. The riveted handles are made of cast stainless steel.

Stewpan with magnetic bottom INDUCTION and st/steel lid



Code	Designation	Øcm	Hcm	Liters.	Th.mm	Bottom ø cm	Kg
6242.16		16	8,8	1,8	2	13,5	1,54
6242.20		20	10,3	3,3	2	17	2,21
6242.24		24	12,3	5,4	2	22	3,22
6242.28		28	13,5	8	2	25	4,07

This stewpan made of copper and stainless steel on the inside has a magnetic bottom and is adapted to all hotplates, including INDUCTION. The riveted handles are made of cast stainless steel.

WOK with 2 cast st/steel handles



Code	Designation	Øcm	Lcm	Hcm	Liters.	Th.mm	Bottom ø cm	Kg
6247.32	ø bottom 10 cm	32		12,5	4	2	17	2,5
3329.10	Grid for wok ø 32 cm		34,5					0,14
3429.32	Glass lid with stainless steel handle	32						1,1

Care :

- **The COPPER outside** : the colour changes on a heat sources. Use a special copper cleaner to give brilliance back to a copper utensil. Never use a metal sponge.
- **The STAINLESS STEEL inside** : easy care with a sponge and washing-up liquid.
- If you burn food in your utensil Inocuvre, soak during half a day with water and washing-up liquid.
- Cleaning in the dishwasher is not recommended. The copper utensils with cast steel handles may rust.

Stainless steel steamcooker



Code	Designation	Øcm	Kg
3675.24		24	0,66

Steaming is a quick operation with this steamer with fits on the copper pans. Equipped with an handle. Tip from the chef: to make your vegetables glisten, plunge them into cold water once they are cooked.



COPPER STAINLESS STEEL INDUCTION

- Copper outside 90% = excellent heat diffusion
- Stainless steel inside 10% = matchless hygiene - ease of use
- Ergonomic cast steel riveted handles
- All heat sources including induction
- Made in France

PRIMA  
MATERA

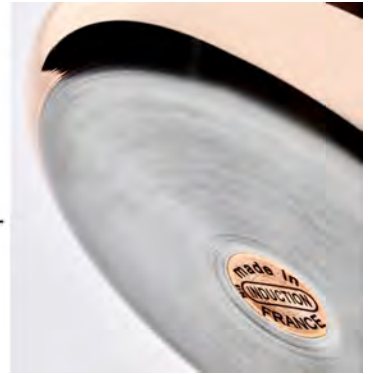

Saucepan with magnetic bottom INDUCTION, cast iron handle



Code	Designation	Øcm	Hcm	Liters.	Th.mm
6306.14		14	7,3	1,2	2
6306.16		16	8,3	1,8	2
6306.18		18	9,3	2,5	2

This design of pan is the utensil professional kitchens can't do without. It is especially suited to boiling down (sauce making...). The walls are stainless steel on the inside. The cast steel handle is firmly riveted. 2mm-thick (90% copper and 10% stainless steel).

Sauté pan with magnetic bottom INDUCTION, cast iron handle



Code	Designation	Øcm	Hcm	Liters.	Th.mm
6330.24		24	6,6	3	2

The copper lid6463 is suitable for this PRIMA MATERA pans with cast steel handles (except frypan).

Lid, cast-iron handle



Code	Designation	Øcm	Th.mm	Kg
6463.14		14	1,2	0,21
6463.16		16	1,2	0,27
6463.18		18	1,2	0,35
6463.20		20	1,2	0,41
6463.24		24	1,2	0,68
6463.28		28	1,2	0,8

The inside of the lid is stainless steel. The handle is made from cast steel and is firmly riveted.



Rounded sauté pan INDUCTION with copper lid, cast iron handles



Code	Designation	Øcm	Hcm	Liters.	Th.mm
6332.28		28	10	4,9	2

Conical sauté pan with magnetic bottom INDUCTION, cast iron handle



Code	Designation	Øcm	Hcm	Liters.	Th.mm
6336.20		20	7,2	1,7	2

This flared sauté pan is ideal for boiling down cooking juices. That's often one of the reasons it's the professionals' first choice. The st/steel lid 3709 is suitable for the PRIMA MATERA pans (except frypan).

Frypan with magnetic bottom INDUCTION, cast iron handle



Code	Designation	Øcm	Hcm	Th.mm
6324.24		24	4	2
6324.28		28	4	2
6324.32		32	5,5	2

Stewpan with magnetic bottom INDUCTION with lid , cast iron handles



Code	Designation	Øcm	Hcm	Liters.	Th.mm
6342.16		16	8,8	1,8	2
6342.20		20	10,3	3,3	2
6342.24		24	12,3	5,4	2
6342.28		28	13,5	8	2

The stewpan has high sides, which allows you to simmer food or cook large volumes of liquid, vegetables, etc. The moisture stays in the pot. The walls are stainless steel on the

inside. The handles are firmly riveted.





INOCUIVRE

- Copper outside 90% = excellent heat diffusion
- Stainless steel inside 10% = matchless hygiene - ease of use
- Ergonomic cast stainless steel riveted handles
- All heat sources except induction
- Made in France

# INOCUIVRE



Saucepan



Code	Designation	Øcm	Hcm	Liters.	Th.mm	Kg
6406.14		14	7,8	1,2	1,5	0,63
6406.16		16	9	1,8	1,5	0,97
6406.18		18	10	2,5	1,5	1,37
6406.20		20	10,7	3,3	1,5	1,9

A new 2mm-thick (90% copper and 10% stainless steel) professional and smart line INOCUIVRE.

Round frypan



Code	Designation	Øcm	Hcm	Th.mm	Kg
6424.20		20	3,5	2	0,95
6424.24		24	3,7	2	1,3
6424.28		28	3,6	2	1,55

It is the perfect frypan for quick cooking. It will also be an elegant product in your kitchen thanks to its design.



Sauté pans



Code	Designation	Øcm	Hcm	Liters.	Th.mm	Kg
6430.16	Straight sauté-pan	16	5,8	1	1,5	0,75
6430.20	Straight sauté-pan	20	6,5	1,8	1,5	1,08
6430.24	Straight sauté-pan	24	7,5	3	2	2
6436.20	Conical sauté-pan	20	7,2	1,7	1,5	1,32
6436.24	Conical sauté-pan	24	7,5	3,1	2	1,8

Made up of 90% copper and 10% stainless steel, this sauté-pan will ensure you a good heat convection and is easy to clean.

Stainless steel lid



Code	Designation	Øcm	Th.mm	Kg
3709.14N		14	1	0,24
3709.16N		16	1	0,28
3709.18N		18	1	0,33
3709.20N		20	1	0,39
3709.24N		24	1	0,51
3709.28		28	1	0,65

This lid is made to fit all kitchenware in this range, except round frypans.

Sauté pan with 2 cast stainless steel handles with lid



Code	Designation	Øcm	Hcm	Liters.	Th.mm	Kg
6441.20		20	6,2	1,8	1,5	1,5
6441.24		24	7	3	2	2,38
6441.28		28	9	4,9	2	3,36

With a 2 mm thickness this sauté pan allows quick browning of food. It is really practical and elegant.



**Stewpan with 2 cast stainless steel handles with lid**



Code	Designation	Øcm	Hcm	Liters.	Th.mm	Kg
6442.16		16	9	1,8	1,5	1,28
6442.20		20	11	3,3	1,5	2,23
6442.24		24	12	5,4	2	3,25
6442.28		28	13,5	8	2	3,96

The stewpan has high sides which allows you to simmer food or cook large volumes of liquid, vegetables, etc. The moisture stays in the pot. The material that composes it offers an extraordinary cooking quality.

**Roasting-pan - copper st/steel - with 2 riveted cast st/steel handles**



Code	Designation	Lcm	Wcm	Hcm	Th.mm	Kg
6427.35	Roasting pan	41	27	8	2	2,2

Multilayer material : copper alu st/steel  
 Handles made of cast stainless steel  
 Suitable also for domestic oven.





### Saucepan, cast-iron handle



Code	Designation	Øcm	Hcm	Liters.	Th.mm	Kg
<b>6460.01</b>	Set of 5 - ø12-20 cm					8,28
<b>6460.12</b>		12	7	0,8	1,5	0,77
<b>6460.14</b>		14	7,5	1,2	1,5	1,23
<b>6460.16</b>		16	9	1,8	1,5	1,3
<b>6460.18</b>		18	9	2,5	1,5	1,61
<b>6460.20</b>		20	10,8	3,3	1,5	1,96

This design of pan is the utensil professional kitchens can't do without. It is especially suited to boiling down (sauce making...). The walls are stainless steel on the inside. The cast steel handle is firmly riveted. 2mm-thick (90% copper and 10% stainless steel). All

hotplates except induction.

### Sauté-pan, frypan, cast iron handle



Code	Designation	Øcm	Hcm	Liters.	Th.mm	Kg
<b>6464.16</b>	Conical sauté-pan, no lid	16	6	0,9	1,5	0,9
<b>6464.20</b>	Conical sauté-pan, no lid	20	7	1,7	1,5	1,38
<b>6464.24</b>	Conical sauté-pan, no lid	24	8	2,9	2	1,93
<b>6462.16</b>	Sauté-pan, no lid	16	5,5	1	1,5	0,84
<b>6462.20</b>	Sauté-pan, no lid	20	6	1,8	1,5	1,45
<b>6462.24</b>	Sauté-pan, no lid	24	7	3,1	2	2,15
<b>6462.28</b>	Sauté-pan, no lid	28	8,5	4,9	2	2,85
<b>6465.20</b>	Frypan	20	3,4		2	1,04
<b>6465.24</b>	Frypan	24	4,2		2	1,48
<b>6465.28</b>	Frypan	28	3,6		2	1,7
<b>6465.32</b>	Frypan	32	5		2	2,44

Heavy duty sauté pans and frying pans are utensils professional kitchens can't do without. The straight-sided sauté pan allows quick browning of food, the tapered sauté pan is ideal for boiling down sauces, and the frying pan turns out to be perfect for frying, searing, and flambéing food. The walls are stainless steel on the inside. The cast steel handle is firmly riveted. All hotplates except induction.

### Lid, cast-iron handle



Code	Designation	Øcm	Th.mm	Kg
<b>6463.12</b>		12	1,2	0,17
<b>6463.14</b>		14	1,2	0,21
<b>6463.16</b>		16	1,2	0,27
<b>6463.18</b>		18	1,2	0,35
<b>6463.20</b>		20	1,2	0,41
<b>6463.24</b>		24	1,2	0,68
<b>6463.28</b>		28	1,2	0,8

The inside of the lid is stainless steel. The handle is made from cast steel and is firmly riveted.





Stewpan with lid, cast-iron handles



Code	Designation	Øcm	Hcm	Liters.	Th.mm	Kg
6466.16		16	8,8	1,8	1,5	1,5
6466.20		20	10,5	3,3	1,5	2
6466.24		24	12,5	5,4	2	3,24
6466.28		28	13,5	8	2	4,05

The stewpan has high sides, which allows you to simmer food or cook large volumes of liquid, vegetables, etc. The moisture stays in the pot. The walls are stainless steel on the inside. The handles are firmly riveted. All hotplates except induction.

High stewpan with lid



Code	Designation	Øcm	Hcm	Liters.	Th.mm	Kg
6467.24		24	18,5	7,5	2	3,67

All hotplates except induction.

Stockpot with lid



Code	Designation	Øcm	Hcm	Liters.	Th.mm	Kg
6468.20		20	18,5	5,7	2	2,9

All hotplates except induction.

# INOCUIVRE



INOCUIVRE Copper 90% Stainless steel 10%

Ergonomic brass riveted handles

Suitable for cooking as well as presentation on table and making flambés

All heat sources except induction



## Saucepan



Code	Designation	Øcm	Hcm	Liters.	Th.mm	Kg
6445.10		10	5,2			0,33
6445.12		12	6	0,8	1,5	0,5
6445.14		14	7	1	1,5	0,63
6445.16		16	8,5	1,6	1,5	0,8
6445.18		18	9	2,5	1,5	0,99
6445.20		20	10	3,5	1,5	1,21

This design of pan is especially well adapted to the table and making flambés or can be used simply to decorate the kitchen interior. It can also be used for cooking on medium-power heat sources. The walls are stainless steel on the inside, which makes

for easy upkeep and removes the need for re-tinning. Riveted brass handle.

## Sauté-pan without lid



Code	Designation	Øcm	Hcm	Liters.	Th.mm	Kg
6448.16		16	5	1	1,5	0,75
6448.20		20	6	1,8	1,5	0,94
6448.24		24	6,5	3	2	1,81

The straight-sided sauté pan allows quick browning of food and proves ideal for serving and for flambéing. The walls are stainless steel on the inside, which makes for easy upkeep and removes the need for re-tinning. The brass handle is firmly riveted.

## Frypan with brass handle



Code	Designation	Øcm	Hcm	Th.mm	Kg
6450.20		20	3	2	0,91
6450.24		24	4	2	1,3
6450.28		28	4,5	2	1,82

These frying pans in stainless-lined copper prove perfect for frying and searing using medium-power heat sources, for flambéing food, and give a perfect appearance on the table. The skirt is stainless steel on the inside, which makes for easy upkeep and removes the need for re-tinning. The brass handle is firmly riveted.



Round dish, 2 handles



Code	Designation	Øcm	Hcm	Th.mm	Kg
6449.12		12	2	2	0,34
6449.16		16	3	2	0,55
6449.20		20	3	2	0,78
6449.24		24	4,2	2	1,23

This round dish is used a lot for cooking eggs, making gratins, or perhaps for making crème brûlées. It makes for an elegant appearance on the table. The skirt is stainless steel on the inside, which makes for easy upkeep and removes the need for re-tinning.

The brass handles are firmly riveted.

Oval dish, 2 handles



Code	Designation	Lcm	Wcm	Hcm	Th.mm	Kg
6451.32		32	23	4,5	1,5	1,02
6451.36		36	26,2	4,5	1,5	1,2

The dish proves ideal for serving and for flambéing. The skirt is stainless steel on the inside, which makes for easy upkeep and removes the need for re-tinning. The brass handles are firmly riveted.

Sauté-pan with lid, brass handles



Code	Designation	Øcm	Hcm	Liters.	Th.mm	Kg
6446.20		20	6	1,8	1,5	1,44
6446.24		24	7	3,2	2	2,48
6446.28		28	9	5,5	2	3,37

The two-handed sauté dish allows quick browning of food. It has the same uses as a one-handed sauté pan, but turns out to be more practical to handle and takes up less space when stored away or when on the burner. The walls are stainless steel on the inside.

The brass handles are firmly riveted.

Round stewpan with lid



Code	Designation	Øcm	Hcm	Liters.	Th.mm	Kg
6447.10	mini stewpan with lid	10	5,5			0,48
6447.16		16	8	1,6	1,5	1,04
6447.20		20	10	3,5	1,5	1,59
6447.24		24	11,5	5,2	2	3,13



This casserole is an elegant way of serving at the table. It can also be used for cooking on medium-power heat sources. The skirt is stainless steel on the inside, which makes for easy upkeep and removes the need for re-tinning. The brass handles are firmly riveted.

## Mini pans , copper st/steel with brass handles



Code	Designation	Øcm	Hcm	Liters.	Kg
6447.10	mini stewpan with lid	10	5,5		0,48
6453.09	Saucepan with lid	9	4,5	0,3	0,21
	Saucepan without lid				
6445.09		9	4,5	0,3	0,2
6445.10		10	5,2		0,33

The small saucepan is perfect for serving sauces. It ensures an elegant appearance. The walls are stainless steel on the inside, which makes for easy upkeep and removes the need for re-tinning. The brass handle is firmly riveted.

## Lid



Code	Designation	Øcm	Th.mm	Kg
6454.09	Round handle	9		0,09
6454.10	Round handle	10		0,1
6454.12		11,5	1,2	0,17
6454.14		13,5	1,2	0,21
6454.16		15	1,2	0,29
6454.18		17	1,2	0,36
6454.20		19,5	1,2	0,42
6454.24		23,5	1,2	0,62
6454.28		27	1,2	0,82

The inside of the lid is stainless steel. The brass handle is firmly riveted.

## Universal stainless steel lid, for frying pans

new  
2023



Code	Designation	Øcm	Th.mm	Kg
3460.02	Suitable for frypans ø 20 - 24 cm	25	0,8	0,35
3460.03	Suitable for frypans ø 26 - 28 cm	29	0,8	0,45
3460.04	Suitable for frypans ø 30 - 32 cm	34	0,8	0,61

Stronger design for stability.  
Sturdy without being heavy.  
De Buyer stainless steel knob: easy to grab and place upside down.  
Non-flat surface: limits excess water on kitchen countertop.  
Gloss polish finish.



**Copper massive conical jam pans with cast-iron handles**



Code	Designation	Øcm	Hcm	Liters.	Th.mm	Kg
<b>6200.38N</b>	Conical jam pan, 1 mm th	38	15	9	1,2	1,5
<b>6202.40N</b>	Conical jam pan, 2 mm th	40	14,4	12	1,7	3,4

These copper basins are genuine traditional utensils used for bringing sugar or fruit to a boil to make jams, jellies, or preserves. The cast steel handles are firmly riveted.

**Copper "Canelés Bordelais" fluted moulds**



Code	Designation	Øcm	Hcm	Liters.	Th.mm	Kg
TINNED COPPER						
<b>6820.35N</b>		3,5	3,3	0,03	0,8	0,01
<b>6820.45N</b>		4,5	4,2	0,06	1	0,03
<b>6820.55N</b>		5,5	5	0,1	1,2	0,05

These moulds allow you to use the traditional method for making Bordeaux's famous crunchy Canelé cakes. The copper ensures perfect heat convection, which allows good caramelization of the juices and gives a delicious taste.

**Copper eggwhites bowl**



Code	Designation	Øcm	Th.mm	Kg
<b>6580.20</b>	1 ring-handle	20	1,2	0,91
<b>6580.26N</b>	1 ring-handle	26	1,2	1,06
<b>6580.32</b>	1 ring-handle	32	1,2	1,63

Made from solid copper, these half-round eggwhite basins are the traditional utensils used by professionals. The basins are perfect for beating egg-whites until stiff.



**Copper cleaner**

Code	Designation	Liters.	Kg	PU
<b>4200.01N</b>	150 ml	0,15	0,24	6



This cleaner gives brilliance back to your utensils. It is really easy to use: First, clean your pan. Wet the sponge with hot water and dip it in the cleaner. Rub the whole pan with the sponge. Then rinse it with hot water and dry it carefully.







# ESSENTIAL ACCESSORIES

From bowls to spatulas and whisks, De Buyer utensils are designed to work like natural extensions of your hand. They are ergonomic and comfortable to use. Especially noteworthy are our exclusive De Buyer piston funnels and “Le Tube” pressure pastry syringe, all with the “Origine France Garantie” label.

---

- 102 -  
Lids for pans

- 104 -  
St/steel utensils for preparation  
Automatic dispensers  
LE TUBE

- 114 -  
Small utensils, whisks  
& spatulas

- 127 -  
Seafood utensils



- 129 -  
Pizza accessories

- 131 -  
Thermometers





# COOKING ACCESSORIES • LIDS

TABLE CAPTION		St. steel lid 3709 pages 59, 86, 92	Brushed st. steel lid 3509 pages 63, 68	St. steel lid for FRYING PAN 3460 page 13	
					
✓ Recommended	• Lid material	St. steel		St. steel	
	• Knob material	St. steel		S. steel	
	• Rim height	Deep		Short	
✓ Compatible					
	STEEL	MINERAL B			
		MINERAL B BOIS	Country pans and woks		
MINERAL B PRO					
STAINLESS STEEL	AFFINITY	All models except for frying pans and woks	✓	✓	
		Wok Ø 32 cm			
	ALCHIMY	All models except frying pans	✓	✓	
	MILADY	All models	✓	✓	
	PRIM' APPETY	All models	✓	✓	
NON-STICK	CHOC EXTRÊME	Frying pans	✓		
		Sauté-pans		✓	
		Wok Ø32 cm with 2 handles		✓	
		Sauté pan wit 2 handles	✓	✓	
	CHOC INTENSE	Frying pans and sauté-pans			
	CHOC B BOIS				
COPPER	PRIMA MATERA (cast st. steel handles)	All models except frying pans	✓		
	PRIMA MATERA (cast iron handles)				
	INOCUIVRE (cast st. steel handles)	All models except frying pans	✓		
	INOCUIVRE (cast iron handles)				
	INOCUIVRE (brass handles)				
STEAMCOOKER 3675.24			✓		
EVERY COLLECTION		Frying pans Ø 20 to 32 cm		✓	





**Flat bottom pastry bowl, round opened edge**



Code	Designation	Øcm	Hcm	Liters.	Th.mm	Kg
3250.16		16	9	1	0,8	0,19
3250.20		20	10	2	0,8	0,24
3250.24		24	11,2	3,5	1	0,4
3250.28		28	12,5	5,5	1	0,56
3250.32		32	14	8	1	0,74
3250.36		36	15	11,5	1,2	1,1
3250.40		40	17,5	16	1,2	1,42

Bowls for professional use, as much for their capacity as for the quality and thickness of the stainless steel used. They have an open rolled rim: rolled for handling without injury and open for improved hygiene. Polished finish.

**Hemispherical bowl, round opened edge**



Code	Designation	Øcm	Liters.	Th.mm	Kg
3372.16N		16	1	0,7	0,23
3372.20		20	2,1	0,7	0,35
3372.24		24	3,6	0,7	0,49
3372.30		30	7	0,7	0,7
3371.35		35	11,2	0,8	1,01
3371.40		40	16,8	0,8	1,35

Code	Designation	Th.mm	Kg
3379.00	Round stand for hemispherical bowl For ø 20 - 24 cm	1	0,11
3379.01	For ø 30-35-40 cm	1	0,18

This stainless steel bowl, with its splayed skirt, owes its name to its round base. Its half-spherical form allows for the preparation to be well aerated during mixing, which is performed with downward movements. Inseparable from its whisk, the cul-de-poule is the ideal utensil for easily and rapidly making floating islands or emulsions.

- Professional stainless steel - Robust and undistortable
- Gloss polished outside & satin polished inside
- Hemispherical for a good ventilation of the preparation during mixing
- Open rim for perfect hygiene
- Rolled rim for handling without injury

**Hemispherical pastry bowl, stainless steel and silicone**



Code	Designation	Øcm	Liters.	Th.mm	Kg
3373.16		16	1	0,7	0,24
3373.20		20	2,1	0,7	0,37
3373.24		24	3,6	0,7	0,5
3373.30		30	7	0,7	0,73

De Buyer has developed a stainless steel, and never slips during use. The interior graduations are also practical. The bowl is stable

**Hemispherical pastry bowl made of foodgrade polyethylene**



Code	Designation	Øcm	Hcm	Liters.	Kg
4530.17		17,5	8	1	0,08
4530.23		23	10,5	2,5	0,16
4530.27		27,5	12	4,5	0,2
4530.32		32	14,5	6	0,26
4530.36		36	16	9	0,3
4530.40		40	18	13	0,4
4530.90	Set of 6 bowls from 1 L. to 13 L.				1,4

Dishes



Code	Designation	Lcm	Wcm	Hcm	Liters.	Th.mm	Kg	PU
3283.27		27	22	4	1,9	1	0,63	10
3283.30		30	25	4,3	2,6	1	0,79	10
3280.35		35	27	4,6	3,6	1	0,97	10
3280.40		42	32	5	4,9	1	1,24	5

These stainless steel dishes are particularly resistant to knocks that happen during the course of handling. Besides this, they comply with professional dimensions.

Stainless steel conical colander with base and 2 handles



Code	Designation	Øcm	Lcm	Hcm	Th.mm	Kg
3930.32		29,4	39,5	14,4	1	0,8
3930.40		36,5	49	17	1,2	1,47
3930.48		44,6	58	19,3	1,2	2,14

This colander is made from 1.2mm (18 gauge) stainless steel, making it very robust and knock resistant. High quality.

Stainless steel colander - Professional quality



Code	Designation	Øcm	Lcm	Hcm	Th.mm	Kg
3232.24	Conical, 1 handle	23,5	45	11	1	0,57
3232.28	Conical, 1 handle	27	54	12	1	0,76

Colanders made from food-grade stainless steel. 3 different models are available. The colanders with a handle and a hook can be hitched onto the rim of a pan during straining. Perforations ø 3 mm

Kitchen Chinese strainer, heavy - Perforation 1,5 mm



Code	Designation	Øcm	Hcm	Th.mm	Kg
3350.10N (1)		10	7,1	0,4	0,08
3350.14N (2)		14	10,5	0,4	0,15
3350.18N		18,5	16	0,4	0,31
3350.20N		20	18	0,4	0,38
3350.23N		23	20,5	0,4	0,45
3350.26N		27	23	0,4	0,71
3354.01	Non-slip stainless steel stand		15	6	0,17

Range of different sizes made from heavy, extra-wear-resistant stainless. There is a hook opposite the handle to fit the conical strainer inside a pan. You can place the conical strainer on the stand of a piston funnel to avoid spilling the contents.



Bakery chinese strainer, micro-perforated 0,8 mm



Code	Designation	Øcm	Hcm	Th.mm	Kg
3351.23	chinese strainer ø 23 cm	23	22	1	0,56
3354.01	Non-slip stainless steel stand		15	6	0,17

Looking for all the world like its cousin the conical kitchen strainer, the stainless steel pastrycook's strainer has the added feature of micro perforations, making it as efficient as a muslin strainer but with several advantages: hygiene, toughness, and safety. This conical strainer is professional-grade and extremely solid.

Especially easy cleaning.



**Pusher for chinese strainer made of beechwood**



Code	Designation	Lcm	Wcm	Kg
3350.90		25,5	5	0,19

**Stainless steel frame muslin strainer - Twile mesh 0,4 mm**



Code	Designation	Øcm	Lcm	Hcm	Th.mm	Kg
3352.20N		20	44	18	0,6	0,48
	Handle thickness : 2 mm					
	Reinforced with its ø 4mm st/steel wire to protect the mesh					

This strainer is fitted with a hook and a tongue enabling it to sit on round bowls. Hole mesh size: 0,4mm. It allows for the very fine filtration of gelatin, coulis or custard. 40 mesh.

**Deep stainless steel frame muslin strainer - Twile mesh 0,4 mm**



Code	Designation	Øcm	Lcm	Hcm	Kg
3352.22		22	45	23	0,57

**Stainless steel sieve with 4 removable meshes**

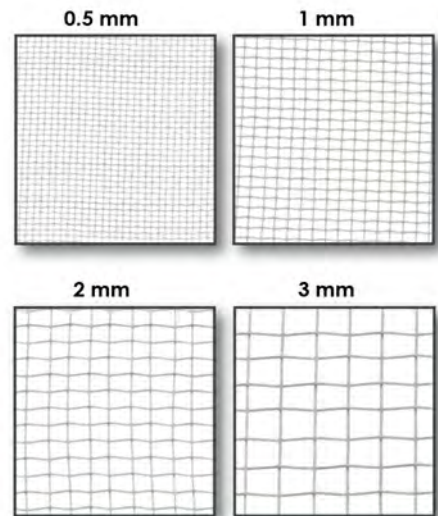

Code	Designation	Øcm	Kg
4605.21	mesh 3 mm/2 mm/1 mm/0,5 mm	20	0,37

- USES :
- Mesh 0.5 mm : flour, icing sugar
  - Mesh 1 mm : almond or hazelnut flour
  - Mesh 2 mm : purées, fish mousse
  - Mesh 3 mm (screen) : Peeling hazelnuts, chopped pralines mixes, marzipan grater

**Stainless steel flour sieve with st/steel mesh N° 20 - mesh 0,8 mm**



Code	Designation	Øcm	Hcm	Kg
4604.16		16	5,5	0,11
4604.21		21	6	0,19
4604.30		30	7	0,31

**Strainer, st. steel**



Code	Designation	Øcm	Lcm	Kg
	Mesh thickness 0,27 mm			
3242.10N		10	25,5	0,08
3242.12N		12	32,5	0,11
3242.14N		14	35	0,13
3242.16N		16	37	0,2
3242.18N		18	40	0,22

Perforated stainless steel strainer

**Dredger, stainless steel**



Code	Designation	Øcm	Hcm	Liters.	Kg
4782.00N	Sugar dredger with metal mesh (1)	7	13	0,5	0,17
4782.01N	Sugar dredger with metal mesh	7	10	0,31	0,14
4783.00N	Sugar dredger - small holes ø1,5 mm (2)	7	13	0,5	0,17
4783.02N	Sugar dredger - small holes ø1,5 mm	7	10	0,31	0,14
4783.01N	Spices dredger - large holes (3) 2,5 mm	7	13	0,5	0,17
4783.03N	Spices dredger - large holes 2,5 mm	7	10	0,31	0,14

The perforated metal sprinkler is ideal for sprinkling with icing sugar. It comes with a bayonet-fitting top.

**Stainless steel professional food mill and sieves**



Code	Designation	Øcm	Lcm	Hcm	Kg
2004.00N	Professional mill N° 5 without sieve	37	41	38,5	3,1
2004.10N	Sieve for N°5, ø 1 mm				
2004.15N	Sieve for N°5, ø 1,5 mm				
2004.20N	Sieve for N°5, ø 2 mm				
2004.30N	Sieve for N°5, ø 3 mm				
2004.40N	Sieve for N°5, ø 4 mm				
2007.00N	Semi-professional mill N° 3 delivered with 3 sieves 1,5mm - 2,5 mm - 4 mm	31			3

This professional stainless steel food mill lets you prepare puree, stewed fruit, fish soup, vegetable soup, etc. Three models of sieve fit onto it, each with different sized perforations.



**Graduated bucket with base**



Code	Designation	Øcm	Hcm	Liters.	Th.mm	Kg
3276.12N	Inner ø 29 cm	31	28,5	12	1,5	1,34

Food-grade stainless steel bucket for holding any kind of food or liquid. Internal graduations every litre (except the 5 litre model).

**Bucket without base**



Code	Designation	Øcm	Hcm	Liters.	Th.mm	Kg
3274.12N	Grad. - inner ø 29 cm	31	27	12	1,5	1,2

food-grade stainless steel bucket for holding any kind of food or liquid. Internal graduations every litre (except the 7 litre model).

**Measuring jug with foot, handle and with a spout**



Code	Designation	Øcm	Hcm	Liters.	Th.mm	Kg
3565.05N		10	10,5	0,5	0,3	0,14
3565.10N		13,5	14	1	0,3	0,24
3565.15N		14	15	1,5	0,3	0,33
3565.20N		16	18,5	2	0,3	0,41
Small measuring jug with handle without foot						
3565.010N		6,8	4,5	0,1	0,2	0,03
3565.025N		8,5	7	0,25	0,2	0,07

This food-grade stainless steel measuring jug facilitates cooking and lets you measure liquids quickly. Easy to handle with its handle and pouring lip. Can be sterilized.

**Scoop, st. steel**



Code	Designation	Lcm	Wcm	Hcm	Liters.	Th.mm	Kg
3271.20	Flour scoop, with handle 75 cl	20	12	5,5	0,75	1,5	0,41
3271.24	Flour scoop, with handle 1,4 L	24	15	6,5	1,4	1,5	0,53

These stainless steel scoops ensure perfect hygiene. The stainless tube handle is welded.

**Flour scoop , polypropylene**



Code	Designation	Lcm	Liters.	Kg
4370.02N		26	0,25	0,04
4370.05N		32	0,5	0,07
4370.09		39	0,9	0,12

This very practical measuring scoop is made from food-grade polypropylene.

**Graduated measuring jug, polypropylene**



Code	Designation	Hcm	Liters.	Kg
4021.05N		14	0,5	0,05
4021.10N		17	1	0,1
4021.20N		21,5	2	0,2
4021.30N		24	3	0,3
4021.50N		27	5	0,4

Graduated in litres and millilitres. Pouring lip and handle. Can be used from 0°C to 125 °C.



Set of 4 measuring cups: 60 - 80 - 125 - 250 ml



Code	Designation	Kg
4827.02	1/4 cup - 1/3 cup - 1/2 cup - 1 cup	0,4

1/4 cup - 1/3 cup - 1/2 cup and 1 cup

Set of 4 measuring spoons : 1 / 2,5 / 5 / 15 ml



Code	Designation	Kg
4827.01	1/4 tsp - 1/2 tsp - 1 tsp - 1 tbsps	0,08

Ice-cream scoop made of cast aluminium with eutectic handle system



Code	Designation	Lcm	Wcm	Kg	PU
4815.00N	Width of the bowl : 4,5 cm	18	4,5	0,11	5

Designed for a better productivity with its shape and the sharp edges. Equipped with a stop drop edge and a flat base : stable and practical. When gripped, the eutectic (thermoactive) handle spreads the warmth over the whole spoon as the scoops of ice-cream are being molded to shape. This allows

the scoops to be molded more easily. Waterproof. NOT dishwasher safe.

Ice-cream scoop - Stainless steel



Code	Designation	Øcm	Lcm	Liters.	Kg
4826.05N	Portion 80ml = 1/12,5 L	6,3	23,1	0,08	0,15
4826.04N	Portion 60ml = 1/16 L	5,8	22,5	0,06	0,15
4826.03N	Portion 40ml = 1/25 L	5	21,5	0,04	0,14

Funnel



Code	Designation	Øcm	Hcm	Kg
3357.12	Funnel with filter	11,6	12,9	0,13
3357.20	Funnel with filter	19,5	20,7	0,31
3356.12N		11,6	12,9	0,13
3356.20N	Funnel without filter	19,5	20,7	0,24
3357.01	All stainless-steel filter for funnel			0,02

This stainless steel funnel is available in two models, with filter (reference 3357) and without (reference 3356). The removable filter model ensures perfect hygiene. The filter fits inside funnel reference 3356

Stainless steel funnel for jam and to pour preparations in ring



Code	Designation	Kg
3356.00	2 parts for ø from 3,5 to 6 cm	0,23

This funnel is also practical to pour preparations in ring for arranging filling on a dish.



# AUTOMATIC DISPENSER BY DE BUYER

Filling, Pouring, Garnishing, decorating



3353



3354.12



3354.02



3354.52



3358.00

Capacity	0,8 L.	1,5 L.	1,9 L.	3,3 L.	0,8 L.
Nozzle	ø 7 mm 80°C max.	3 sizes: ø 8 mm and nozzles ø 4 & 6 mm	3 sizes: ø 8 mm and nozzles ø 4 & 6 mm	3 sizes: ø 15 mm and 2 nozzles ø 5 & 10 mm	2 nozzles supplied U8 & D8 Suitable for other nozzle forms
Use:					
	LIQUID FLUID	LIQUID FLUID	LIQUID FLUID	THICK MOUSSES	THICK COMPACT
Sweet or savory sauce	✓	✓	✓	✓	
Hot jelly		✓	✓	✓	
Hot fruit pulp		✓	✓	✓	
Cream Thick fruit coulis				✓	
Hot sirup		✓	✓	✓	
Liqueur	✓	✓	✓		
Mousse				✓	
Cake dough					✓
Mixture for Financiers Madeleines Cakes					✓
Jam				✓	
Puff pastry					✓
Chocolate pastry				✓	✓
Sponge biscuit					✓
Caramel chaud		✓	✓	✓	
Joconde biscuit				✓	
Custard					✓
White cheese Fruit compote				✓	



TEMPERATURE  
RESISTANCE  
+100°C / 212°F  
HITZEBESTÄNDIG



**LE TUBE: Pressure pastry syringe**



Code	Designation	Lcm	Wcm	Hcm	Liters.	Kg
3358.00	LE TUBE delivered with 2 nozzles U8 (ø11 mm) & D8	2023				0,44
3358.01	Delivered with 2 nozzles U8 (ø11 mm) & D8 + 2 caps + biscuits kit REF 3358.94	38,4	10,5		0,75	0,68
3358.92	Set of 2 lids for the tank					0,05
3358.93	Set of 2 lids with hole for the tank					0,05
3358.75	0,75 capacity extra tank + 2 caps ref.3358.92	19,6	8,54		0,75	0,13
3358.95	DISPLAY WITH VIDEO : - 8 boxes Le Tube 3358.01 - 9 sets of 6 Tritan nozzles (3 X 4150.02 / 3 X 4150.03 / 3 X 4150.08) - 5 tanks 3358.75	50	39	150		15,62

Pressure syringe for effortless dosing of paste, creams and mousses.  
For garnishing, filling and decorating. Simple, fast and accurate work. Easier to fill than a pastry bag, 0,75 L. capacity in transparent plastic.  
Graduated in cl and oz. Allows the user to see how much is left.

Knob for easy setting of pressure for dosing the amount to be poured (from 1 to 5 cl).  
Removable and interchangeable nozzles.  
DESIGNED BY DE BUYER - PATENTED

**Box LE TUBE PRO**



Code	Designation	Lcm	Wcm	Hcm	Kg
3358.02	This box includes: - Piston syringe LE TUBE - 4 extra containers 0.75 L. - 12 nozzles with holders: 3 plain nozzles ø 6-11-13 mm 3 star nozzles B8-C8-E8 / 2 star nozzles PF10 - PF14 1 St Honoré / 1 bird nest nozzle 1 garnishing nozzle ø 6 mm 1 garnishing nozzle ø 10 mm	47	30	10	1,82



Special shortbread biscuits kit for LE TUBE



Code	Designation	Kg
3358.94	Special lid disc holder + 13 discs + 2 caps ref.3358.92 to store the paste	0,17

Kit composed with a special lid (disc holder) and 13 removable decor discs.  
Delivered with 2 caps ref. 3358.92  
Fits on LE TUBE.



KWIK - Mini Piston funnel 0,8 liter - Stainless steel



Code	Designation	Øcm	Lcm	Wcm	Hcm	Liters.	Th.mm	Kg
3353.00	Black	15	18,5	15	15,5	0,8	0,4	0,25
3353.20	Green	15	18,5	15	15,5	0,8	0,4	0,25
3353.30	Orange	15	18,5	15	15,5	0,8	0,4	0,25
3353.40	Red	15	18,5	15	15,5	0,8	0,4	0,25
3353.60	Fushia	15	18,5	15	15,5	0,8	0,4	0,25
SPARE PARTS FOR FUNNEL :								
3353.96	kit nozzle nut siphon							
3353.95	Nozzle							

Stainless steel and plastic. Professional standard.  
This mini piston funnel comes with an outlet (7 mm dia. nozzle) and is completely impermeable.  
The funnel is practical and its low capacity (0.8 L) makes it ideal for dispensing small portions of sauce or cream, e.g. for garnishing dishes immediately prior to serving.  
Compact for practical storage.  
Dishwasher safe.



**Automatic piston funnel KWIK PRO, all stainless steel**



Made entirely from stainless, including nuts, wing nuts, spring... for perfect hygiene. Completely leakproof in the closed position: for creams, sauces, or liqueurs... Its ease of use makes it the universal kitchen and bakery tool for :

- Garnishing plates with sauces,
- Pouring jelly into a dish,
- Filling small quiches,
- Filling blini pans with batter,
- Filling chocolate shells with liqueur, etc.

Code	Designation	Øcm	Hcm	Liters.	Th.mm	Kg
3354.00	Automatic piston funnel alone 1,9 L.	19	18	1,9	1	0,61
3354.02	Automatic piston funnel with stand 1,9 L.	19	18	1,9	1	0,78
3354.10	Automatic piston funnel alone 1,5 L.	17,5	16,5	1,5	1	0,55
3354.12	Automatic piston funnel with stand 1,5 L.	17,5	16,5	1,5	1	0,72
3354.01	Non-slip stainless steel stand		15		6	0,17
SPARE PARTS FOR FUNNEL :						
3354.92	Central closed nut					
3354.93	Wing nut					
3354.95	Set of two nozzles - 4 and 6 mm					
3354.89	Mechanism 1,5 L (piston, tie bar, lever, spring)					
3354.99	Mechanism 1,9 L (piston, tie bar, lever, spring)					



**Automatic piston funnel KWIK MAX - 3,3 Liters - All stainless steel**



Code	Designation	Øcm	Wcm	Hcm	Liters.	Kg
3354.52	with stand & 2 nozzles Professional model 3 sizes : ø 15 - 10 and 5 mm	20	30	38	3,3	0,95
SPARE PARTS :						
3354.51	Stand alone					
3354.79	Mechanism					

Big sizes of the integrated nozzle ø 15 mm to preserve air molecules of the preparations: saved smoothness.  
Perfect for mousses, thick sauces, caramel, thick jelly or fruit coulis, etc.  
All st/steel: suitable for very hot preparations.  
The deep cone enables to push and pour naturally without pressure on the mixture.



**B BOIS utensils made of beechwood with a beeswax protective finishing.**

The beech wood used is a wood coming from sustainably managed forests.

*'B Bois' products are exclusively sold via physical retailers.*



**Rounded spatula B BOIS**

**Bevelled spatula B BOIS**



Code	Designation	Lcm	Kg
4870.25		25	0,02
4870.30		30	0,03
4870.35		35	0,05
4870.40		40	0,07

Code	Designation	Lcm	Wcm	Hcm	Kg
4872.25		25	5	0,5	0,02
4872.30		30	5	0,5	0,02
4872.35		35	5,5	0,7	0,03
4872.40		40	6	0,7	0,05

**Mixing spoon B BOIS**



Code	Designation	Lcm	Wcm	Hcm	Kg
4871.20		20	4,5	1,5	0,02
4871.25		25	4,5	1,5	0,02
4871.30		30	5	1,5	0,03
4871.35		35	5,5	1,5	0,05
4871.40		40	6	1,5	0,07



**Pointed spoon B BOIS**



Code	Designation	Lcm	Wcm	Hcm	Kg
4874.00	Special sauce	30	5	1,5	0,04
4874.01	Special for risotto	30	5	1,5	0,03

**Large spatula B BOIS**



Code	Designation	Lcm	Wcm	Hcm	Kg
4875.30		30	8	2	0,05

**Crepe spatula B BOIS**



Code	Designation	Lcm	Wcm	Hcm	Kg
4873.00		30	4,5	0,5	0,02

**Round crepe dough spreader B BOIS**



**Crepe dough spreader B BOIS**



Code	Designation	Lcm	Wcm	Hcm	Kg
4873.01		20,5	16	1,5	0,01

Code	Designation	Lcm	Wcm	Hcm	Kg
4873.02		20	16	3	0,02

**Set of 10 mini spatulas B BOIS**



Code	Designation	Lcm	Wcm	Kg
4873.04		14	4	0,08

**Salad servers B BOIS**



Code	Designation	Lcm	Wcm	Hcm	Kg
4876.00		25	5,5	1,5	0,05

**Toast tong B BOIS**



Code	Designation	Lcm	Wcm	Hcm	Kg
4876.01		21	5	3	0,03



Utensils B BOIS made of old time finishing stainless steel and wooden handle



Code	Designation	Lcm	Wcm	Liters.	Kg
2701.00	Slotted spoon	33,5	6,5		0,1
2701.01	Spoon	33,5	6,5		0,1
2701.02	Ladle	34	9	0,09	0,15
2701.03	Masher	29	7,5		0,14
2701.04	Skimmer	36,5	11		0,15
2701.05	Plain spatula	35	8		0,13

Beechwood handle with beeswax finish.

Utensils B BOIS made of old time finishing stainless steel and wooden handle



Code	Designation	Lcm	Wcm	Kg
2701.06	Slotted spatula	35	8	0,11
2701.07	Flexible turner	30	8	0,07
2701.08	Cake server	27,5		0,07
2701.09	Spaghetti spoon	33	7	0,11
2701.10	Fork	32	3,5	0,08

Beechwood handle with beeswax finish.

Wall hanging bar for utensils with 8 removable hooks - Stainless steel



Code	Designation	Lcm	Wcm	Th.mm	Kg
4720.00		44	2,4	2,5	0,36

Heavy duty 2.5-mm thick stainless steel : do not distort. Brushed stainless steel. Practical in order to have all ustensils at hand. Sliding hooks allow an easier use. Suitable for both utensils equipped with a hook and utensils provided with a hanging hole.

Omelette turner, stainless steel



Code	Designation	Lcm	Wcm	Th.mm	Kg
3294.30		30	28	1,2	0,79

This highly practical omelette spade is for use on snack-bar griddles.

Wire skimmer, extra-strong stainless steel



Code	Designation	Øcm	Lcm	Kg
2601.12N	L. Handle 34 cm	12	34	0,24
2601.14N	L. Handle 35 cm	14	48	0,27
2601.16N	L. Handle 36 cm	16	38	0,29
2601.18N	L. Handle 41,5 cm	18	56	0,35
2601.20N	L. Handle 43,5 cm	20		0,38
2601.22N	L. Handle 45 cm	22	64	0,41

The wire deep-fry skimmer lets you recover and strain food floating in the cooking liquid.



Ladle



Code	Designation	Øcm	Lcm	Liters.	Th.mm	Kg	PU
3136.08	Pizza ladle, flat bottom (1) L. Handle 28 cm	8,2	32	0,15	0,8	0,13	5
3135.04	Mini ladle, round (2) L. Handle 23,5 cm - 2 cl	4	25		0,8	0,04	5
3134.06	Fruit ladle with a spout(3) L. Handle 15,5 cm	6	20	0,05	0,8	0,75	5

Welded shank. The small pouring ladles are ideal for applying toppings or for serving sauces, liqueurs, etc. The small pizza ladle holds 145ml (4 fluid oz) , which is the standard helping of tomato sauce for pizzas; its flat bottom lets you spread the sauce over the pizza pastry.



Stainless steel one-piece ladle



Code	Designation	Øcm	Lcm	Hcm	Liters.	Th.mm	Kg
3021.06	L. Handle 28 cm	6	32,5	3	0,05	1,2	0,1
3021.08	L. Handle 28 cm	8	36	3,7	0,13	1,2	0,15
3021.10	L. Handle 32 cm	10	42	4,7	0,25	1,2	0,24
3021.12	L. Handle 35 cm	12	45	5,7	0,45	1,2	0,29
3021.14	L. Handle 43 cm	14	53	6,5	0,67	1,5	0,48
3021.16	L. Handle 43 cm	16	55,5	8	1	1,5	0,49
3021.20	L. Handle 51,5 cm	20	72	9,7	2,06	1,5	0,71

Single-piece ladles are manufactured in one piece, a guarantee of robustness. The handle is wide and very rigid; its ergonomic shape lets you insert your thumb. This stops the utensils from slipping

round even in greasy or sticky hands. This good handhold avoids a lot of fatigue. The slope of the handle suits all vessels, even deep ones.

Stainless steel one-piece skimmer



Code	Designation	Øcm	Lcm	Th.mm	Kg
3041.08	L. Handle 28 cm	8	34,5	1,2	0,1
3041.10	L. Handle 32 cm	10	41,3	1,2	0,14
3041.12	L. Handle 35 cm	12	44,5	1,2	0,18
3041.14	L. Handle 43 cm	14	53,5	1,2	0,26
3041.16	L. Handle 43 cm	16	55,5	1,2	0,31
3041.18	L. Handle 43 cm	18	57	1,5	0,39
3041.20	L. Handle 51,5 cm	20	67,5	1,5	0,48

Single-piece skimmers are manufactured in one piece, a guarantee of robustness. The handle is wide, very rigid, and ergonomically shaped. The skimmer lets you recover food that has risen to the

surface of the cooking liquid and strain it.

Meat fork



Code	Designation	Lcm	Wcm	Th.mm	Kg
3170.50	L. Handle 38 cm While stocks last	48	4,5	1,5	0,21

Heavy duty range. Stainless steel. The grapplers are made from one piece, a guarantee of robustness. The handle is wide and very rigid and its ergonomic shape lets you insert your thumb. This stops the utensil from slipping round even in greasy or sticky hands.

One-piece ladle with a spout



Code	Designation	Øcm	Lcm	Hcm	Liters.	Th.mm	Kg
3021.66	L. Handle 28 cm	6	32,5	2,8	0,05	1,2	0,1

Stainless steel. All the single-piece ladles are manufactured in one piece, a guarantee of robustness. The handle is wide, very rigid, and ergonomically shaped. Hard to get by without, the pouring ladle is ideal for pouring sauce onto a plate or dish, for serving sangria or other drinks, etc. All without dripping.

Stainless steel one-piece basting spoon



Code	Designation	Lcm	Wcm	Th.mm	Kg
3982.10	STRAIGHT - L. Handle 28 cm	37	6,6	1,2	0,14
3983.10	SIDE - L. Handle 28 cm	36	6,4	1,2	0,14

The basting spoons are all manufactured in one piece. The handle is wide, very rigid, and ergonomically shaped. The spoons allow you to scoop up the juices from meat, fish, etc., and baste with them during cooking.

Stainless steel one-piece spatula



Code	Designation	Lcm	Wcm	Th.mm	Kg
Perforated spatula					
3984.10	L. Handle 35 cm	43,5	9,7	1,2	0,18
3984.12	L. Handle 37,5 cm	47	11,6	1,2	0,22
Plain spatula					
3985.10	L. Handle 35 cm	44	9,8	1,2	0,17
3985.12	L. Handle 37,5 cm	47	11,7	1,2	0,23

Single-piece spatulas are manufactured in one piece, a guarantee of robustness. The handle is wide and very rigid and its ergonomic shape lets you insert your thumb. This stops the utensils from slipping round even in greasy or sticky hands.

HEAVY DUTY UTENSILS  
Stainless steel

Handle thickness = 2,5 mm - Professional and robust  
Ergonomic shape and multi-support hook  
Diameter and/or liter engraved on the handle

Ladle - Heavy quality



Code	Designation	Øcm	Lcm	Liters.	Th.mm	Kg
3130.06	L. handle : 28,2 cm	6	33,5	0,05	2,5	0,14
3130.08	L. handle : 32,9 cm	8	39	0,13	2,5	0,22
3130.10	L. handle : 36,5 cm	10	44,5	0,25	2,5	0,31
3130.12	L. handle : 40,2 cm	12	50	0,45	3	0,45

Heavy duty stainless steel range. The handle is wide and very rigid; its ergonomic shape lets you insert your thumb. This stops the utensils from slipping round even in greasy or sticky hands. This good handhold avoids a lot of fatigue. The slope of the handle suits all vessels, even deep ones.

Skimmer



Code	Designation	Øcm	Lcm	Th.mm	Kg
3150.08	L. handle : 32,5 cm	8	40	2,5	0,2
3150.10	L. handle : 36,5 cm	10	45	2,5	0,25
3150.12	L. handle : 40,2 cm	12	50	3	0,36
3150.16	L. handle : 45,5 cm	16	58,5	3	0,51

Heavy duty stainless steel range. The handle is wide, very rigid, and ergonomically shaped. The skimmer lets you recover food that has risen to the surface of the cooking liquid and strain it.

Perforated one-piece spatula



Code	Designation	Wcm	Th.mm	Kg
3141.10	L. handle : 36,5 cm While stocks last	10	2,5	0,31

Heavy duty stainless steel range. The handle is wide and very rigid and its ergonomic shape lets you insert your thumb. This stops the utensils from slipping round even in greasy or sticky hands.

Plain spatula



Code	Designation	Wcm	Th.mm	Kg
3142.10	L. handle : 36,5 cm While stocks last	10	2,5	0,31

Heavy duty stainless steel range. The handle is wide and very rigid and its ergonomic shape lets you insert your thumb. This stops the utensils from slipping round even in greasy or sticky hands.

Serving spoon



Code	Designation	Liters.	Kg
2140.00	Plain	33	0,08
2140.10	Perforated	33	0,08

Spatula for non-stick frypans



Code	Designation	Lcm	Wcm	Kg	PU
4813.01N		28	6,5	0,03	5

This flexible nylon spatula has rounded edges and is recommended for use with CHOC cooking utensils as it avoids damaging their non-stick coating. Heat resistant.



Spaghetti tong



Code	Designation	Lcm	Th.mm	Kg	PU
4816.21N		20	0,5	0,06	5

Spring tongs that enable spaghetti to be held cleanly during serving. These tongs are also suited to serving grated raw vegetables.

Utility tongs



Code	Designation	Lcm	Th.mm	Kg	PU
4788.24N		24	0,5	0,12	12
4788.30N		30	0,5	0,15	12
4788.40N		40	0,5	0,2	12

The large model is very practical for oven ranges, grills, barbecues...



Skewer, stainless steel



Code	Designation	Lcm	Th.mm	Kg
3401.25	Set of 10	25	2	0,01
3401.30	Set of 10	30	2	0,01
3401.35	Set of 10	35	2	0,01
3401.40	Set of 10	40	2	0,02

Available 25 to 40cm (8" to 12") long, these stainless skewers are made from 2mm (14 gauge) stainless steel and will not bend. The pointed end allows food to be skewered easily.





**Stainless steel tweezer with curved end**



Code	Designation	Lcm	Kg
4239.15		16	0,02
4239.30		30	0,08
4239.35		35	0,17

Tweezer for picking up ingredients and easily handling them, from the thinnest one (herbs, flower, etc.) to the largest one (piece of meat).  
For serving up and decorating plates.

**Stainless steel straight tweezer**



Code	Designation	Lcm	Kg
4238.15		16	0,02
4238.25	L. blade 25 cm	25,5	0,05
4238.30		30	0,08

Tweezer for picking up ingredients and easily handling them, from the thinnest one (herbs, flower, etc.) to the largest one (piece of meat).  
For serving up and decorating plates.

**Stainless steel curved tweezer**



Code	Designation	Lcm	Kg
4237.20		20	0,03

Tweezer for picking up ingredients and easily handling them. For serving up and decorating plates.

# The UNIVERSAL WHISK by DE BUYER

*To Mix, Beat, Aerate, Emulsify...*

The essential utensil for cooking and patisserie :  
the whisk de Buyer is available  
in 7 sizes for preparing :  
Sauces, emulsions, creams, dough, batter...

**Göma**  
**Fouet Universel**

Stainless steel wires  
Spring quality  
Do not loosen  
from handle

Perfectly hygienic  
Can be sterilized

Hole :  
Easy to hang  
and to drain

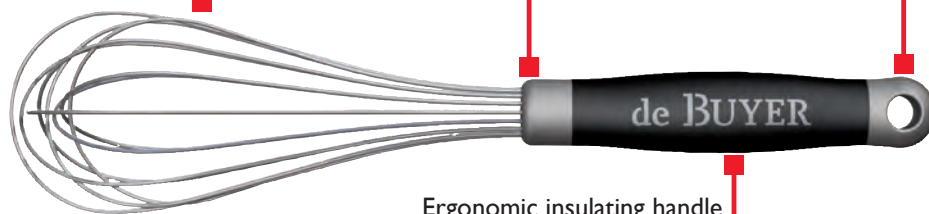

Ergonomic insulating handle

**HEAVY DUTY**  
**PROFESSIONAL**  
**ERGONOMIC**

Overmoulding with TPE  
(Thermo Plastic Elastomer)



Polypropylene



Anti-slip handle with curved design: the whisk will not fall into the pan.



2 possibilities  
to use the whisk



## THE LINE

2610.20 Universal whisk with slim handle L. 20cm. Perfect for using in small pans for sauces.

2610.25 Universal whisk with slim handle L. 25cm

2610.30 Universal whisk with slim handle L. 30cm

The handle of the smaller whisks L. 25 cm and 30 cm is different : Slimmer to ensure comfort for all as well as smaller hands.

2610.35 Universal whisk L.35 cm

2610.40 Universal whisk L.40 cm

2610.45 Universal whisk L.45 cm

2610.50 Universal whisk L.50 cm

EGG-WHITE ROUNDED WHISK :

2611.35 Universal whisk L.35 cm

2611.45 Universal whisk L.45 cm



## PERFECT HYGIENE

Can be sterilized  
Dishwasher safe

For a standard domestic use  
choose a maximum size L. 35 cm for whisks and spatulas



**Universal whisk for cooking and patisserie GÖMA, polypropylene handle**



Code	Designation	Lcm	Wcm	Kg
2610.20	St/steel wire ø 1,4 mm	22,43	5	0,06
2610.25	St/steel wire ø 1,4 mm	26,5		0,08
2610.30	St/steel wire ø 1,8 mm	32		0,14
2610.35	St/steel wire ø 1,8 mm			0,6
2610.40	St/steel wire ø 1,8 mm	41,5		0,19
2610.45	St/steel wire ø 1,8 mm	46,5		0,23
2610.50	St/steel wire ø 1,8 mm	50		0,25

The essential utensil for cooking and patisserie : the professional whisk de Buyer with stainless steel wires -spring quality- Encased wires: perfectly hygienic and watertight. Ergonomic and anti-slip comfortable handle. Easy storage with its hole. Perfect hygiene : Can be sterilized - Perfectly watertight - Dishwasher safe

**Egg-whites whisk GÖMA,, polypropylene handle**



Code	Designation	Lcm	Kg
2611.35	St/steel wire ø 2 mm	35	0,18
2611.45	St/steel wire ø 2 mm	45	0,23

This whisk has a large head and hard springy wires. It is specially designed for beating egg-whites until stiff.





**Rubber flexible scraping spatula Maryse**



Code	Designation	Lcm	Kg
4891.24N	L. handle 18 cm	29	0,07
4891.34N	L. handle 24 cm	37,3	0,1
4891.42N	L. handle 30 cm	43	0,11

A must for pastrycooks, the "Maryse" spatula is flexible and enables containers of all shapes to be scraped out efficiently, recovering all the mixture. Maryse DE BUYER : Non-scratching utensil

- Built-in hook to prevent slippage into bowls - Spoon-shaped blade ideal for scooping and spreading - Dishwasher safe - Maximum heat exposure 100°C (212°F).

**One-piece spatula - high temperature (+260°C) - Nylon handle and silicone blade**



Code	Designation	Lcm	Kg
4740.24N		25	0,08
4740.34N		35	0,11
4740.42N		45	0,13

This flexible spatula makes easy to remove sauces from hard-to-reach spots. Resists to +260°C / 500°F. Keeps out bacteria thanks to one piece construction: silicone blade and plastic handle are moulded together. Easy cleaning - Dishwasher safe.



**White spatula made of polyglass - 220°C-resistant (470°F)**



Code	Designation	Lcm	Kg	PU
4745.25		25	0,04	6
4745.30		30	0,05	6
4745.35		35	0,06	6
4745.40		40	0,08	6
4745.45		45	0,1	6
4745.50		50	0,12	6

Robust and hygienic thanks to the non-porous composite material "polyglass" (polyamid/ glass). The cleaning is easy (dishwasher safe) and the spatula can be sterilized. The rounded shape of the spatula - without edge - enables one to efficiently scrape out the pan. The end of the handle has a rim to prevent the spatula falling into the preparation.

**Spatula made of high quality stainless steel**

**Mirror polished blade :**

- Easy spreading
- Avoids risk of rust - Dishwasher safe

**High flexible blade**

Thinned blade : more thin on the end for a better flexibility and a precise spreading work

**Ergonomic handle**

Robust and resistant made of polyamid reinforced with fiberglass  
 Anti-slip carbon texture  
 Slot for wedging the thumb + finger stopper for a good grip  
 Integrated hook practical to hang the product

MADE IN FRANCE



**Cranked pastry spatula FKOfficium**



Code	Designation	Lcm	Wcm	Kg
4231.15	L. Blade 15 cm	33,5	3,5	0,12
4231.20	L. Blade 20 cm	38,5	3,5	0,13
4231.25	L. Blade 25 cm	43,5	3,5	0,15
4231.30	L. Blade 30 cm	48,5	3,5	0,16

With its angled handle, this spatula makes it easy to spread and level out pasty substances.



**Straight pastry spatula FKOfficium**



Code	Designation	Lcm	Wcm	Kg
4230.15	L. blade 15 cm	29	3,5	0,11
4230.20	L. blade 20 cm	34	3,5	0,12
4230.25	L. blade 25 cm	39	3,5	0,13
4230.30	L. blade 30 cm	44	3,5	0,14

This flat spatula has a rounded end and is ideal for spreading, smoothing, and handling pastries.

**Mini cranked pastry spatula FKOfficium**



Code	Designation	Lcm	Wcm	Kg
4231.08	Pointed blade 8 cm	21	2	0,04
4231.09	Rounded blade 9 cm	22	2	0,04
4231.12	Rounded blade 12 cm	25	2,4	0,05

**Stainless steel flexible turner FKOfficium**



Code	Designation	Lcm	Wcm	Kg
4235.00	L.blade 17 cm	31	7,8	0,1

This food turner is made from forged stainless steel. Its springiness makes food easy to handle and turn.

**Triangular spatula FKOfficium**



Code	Designation	Lcm	Wcm	Kg
4233.01	L. blade 8 cm	26,5	8	0,11

With its special shape, this spatula lets you clean grids and hotplates. Its width and sharp angles also allow you to cut or spread pasty substances or to peel chocolates off their baking sheets.

**Cranked spatola FKOfficium inox**



Code	Designation	Lcm	Wcm	Kg
4232.00	L. blade 12 cm	30	9	0,14
4232.01	Slotted - L. blade 12 cm	30	9	0,12

With its angled handle and rigid blade, this spatula lets you scoop up and turn over hamburger steaks and other meats on snack-bar griddles.

**Cranked service spatula FKOfficium**



Code	Designation	Lcm	Wcm	Kg
4236.00		26,5	5	0,07
4236.01	Slotted	26,5	5	0,06

**Genoise cutter FKOfficium**



Code	Designation	Lcm	Wcm	Th.mm	Kg
4234.25	L. blade 25 cm	39,5	3,5	2	0,14
4234.35	L. blade 35 cm	50	3,5	2	0,16

The sponge-cake slicer lets you slice sideways through sponge cakes evenly, without crumbs, so you can then fill the cake with cream or other fillings.





**Seafood box**



Code	Designation	Lcm	Wcm	Hcm	Kg
<b>4683.90</b>	Box includes : - seafood shears - 4 double seafood forks - an oyster knife	30	20	3,5	0,42

The essential seafood tools gathered in a practical and elegant box.



**Seafood shears with stainless steel blades**



Code	Designation	Lcm	Wcm	Th.mm	Kg
<b>4685.00</b>		20,7	6,5	1,5	0,11

LOCK-AND-SPRING MECHANISM FOR A STRESS-FREE AND SAFE CUT.

Cut hard shellfish leaving meat intact, without cracking nor mess. Ideal for lobster, crab, langouste, shrimp and scampi. Patented.

Large handle - Good grip for all hands. Integrated grip. Detachable stainless steel blades for easy cleaning.

**Set of 4 stainless steel double lobster forks**

Code	Designation	Lcm	Wcm	Kg
4687.00	Set of 4 forks	21	1,8	0,01



DOUBLE FORK : Small and large end to easily remove meat from shellfish.  
 Ideal for lobster, crab and langouste.  
 Ergonomic design for good grip.  
 Robust stainless steel - Dishwasher safe

**Oyster knife with stainless steel blade**

Code	Designation	Lcm	Wcm	Hcm	Kg
4683.00		15,7	4,5	2	0,06



Short and sharp blade made of extra hard stainless steel 420 2CR14.  
 Perfectly sharp blade to easily cut the muscle of the oyster.  
 Polyamide handle with fiberglass. Resistant and non-slip. Length adapted to all hands.

Ergonomic safe handle with slot for thumb and stopper.  
 Handwash recommended - Dishwasher safe

**Oyster mitt**



Code	Designation	Lcm	Wcm	Hcm	Kg
	Extra large model - silicone				
4682.20	For right-handed Mitt on the left hand	23	17	2	0,14
4682.21	For left-handed Mitt on the right hand	23	17	2	0,14

This oyster mitt allows to maintain the oyster during opening. It can not provide a total protection against a misdirected knife. The extra arge model is suitable for the largest handles.





**Pizza cutting wheel**



Code	Designation	Øcm	Th.mm	Kg
<b>4970.10N</b>	Pizza cutting wheel	10	1	0,17

This particularly sturdy pizza cutter has an ergonomic handle for a firm grip. Its stainless steel beveled blade allows pizza to be easily cut into portions.

**Stainless steel pizza ladle - Flat bottom**



Code	Designation	Øcm	Lcm	Liters.	Th.mm	Kg	PU
<b>3136.08</b>	Pizza ladle, flat bottom (1) L. Handle 28 cm	8,2	32	0,15	0,8	0,13	5

Welded shank. The small pizza ladle holds 145ml (4 fluid oz) , which is the standard helping of tomato sauce for pizzas ø 31 cm; its flat bottom lets you spread the sauce over the pizza pastry.

**Perforated pizza screen for cooking - aluminium**



Code	Designation	Øcm	Kg
	Concept AIR SYSTEM		
<b>7350.28</b>		28	0,07
<b>7350.31</b>		31	0,09
<b>7350.33</b>		33	0,1
<b>7350.38</b>		38	0,14
<b>7350.43</b>		43	0,15
<b>7350.48</b>		48	0,21

Perfect for making pizzas, flammenkuche savory tarts, etc. The bottom is perforated to enable you to obtain a crusty-baked pie bottom.

See our complete range of round pizza trays pages 202-203



**Pizza round oven peel - Aluminium with wooden handle**



**Oven peel for pizza or "Flammenküche"**



Code	Designation	Øcm	Lcm	Kg
<b>7291.40</b>	L. handle 120 cm Total length : 162 cm	40	162	0,93

Code	Designation	Lcm	Wcm	Th.mm	Kg
<b>3293.31</b>	Pizza square oven peel L. Handle 96 cm	128	31	1,2	1,35

The food-grade stainless steel rectangular oven spades are especially rugged and will not distort. The shank is made from round tube and its long length lets you stuff pizzas right into the heart of the oven.

**Pizza oven peel, stainless steel**

Code	Designation	Øcm	Lcm	Th.mm	Kg
<b>3290.31</b>	Pizza oven peel - L. Handle 96 cm	31	114	1,2	1,18



The stainless steel handle is made from round tubes and their long length lets you stuff pizzas right into the heart of the oven.

**Pizza square oven peel - Aluminium with wooden handle**



Code	Designation	Lcm	Th.mm	Kg
<b>7293.31</b>	L. handle 120 cm Total L. 152,5 cm	31	1,5	0,89



**Scraper brush for oven, wooden handle**

Code	Designation	Lcm	Wcm	Hcm	Kg
<b>4875.70</b>		71	11,5	5	0,28



The scraper brush is used for brushing the hearth and pushing back the embers in your wood-fired oven.

**Small syrup density meter, metric**

Code	Designation	Lcm	Kg
4591.00N	Grad. from 1100 to 1400 g/L	14	0,19



This professional syrup hydrometer is used for making jam, jelly, liqueur, sorbey, chutney, conserved fruits, etc. It has 2 scales : one in degree baumé (15-40° Baumé) and the other in g./ml (1100-1400 g./ml).

**Mini precision balance with lid - from 0 to 500 gr.**

Code	Designation	Lcm	Wcm	Th.mm	Kg
4887.00		11,5	6,4	1,8	0,13



Accurate scale with lid. Precision 0.1 gr.  
Perfect for spices.  
Fonction tare and auto-off.  
2 batteries 1,5V supplied

**Candy thermometer +80°C / +200°C with stainless steel case**

**Candy thermometer +80°C / +200°C with nylon case**



Code	Designation	Øcm	Lcm	Kg
4884.01N	PRECISION 1/1	0,2	27,5	0,1

Code	Designation	Øcm	Lcm	Kg
4884.00N	PRECISION 1/1	0,35	27,5	0,07

This thermometer is used for pastry and candy. It does not contain mercury, but a less toxic red liquid. It is calibrated to allow for immersion of the lower thinner part of the stem. The protective sleeve can be sterilized at 100°C.

The thermometer and sleeve can be washed in a dishwasher.

This thermometer is used for pastry and candy. It does not contain mercury, but a less toxic red liquid. It is calibrated to allow for immersion of the lower thinner part of the stem. The protective sleeve can be sterilized at 100°C. The thermometer and

sleeve can be washed in a dishwasher.

**Stainless steel oven thermometer - precision from +50°C to + 300 °C**

Code	Designation	Wcm	Hcm	Kg
4885.01	Precision 1/1	6	7	0,54



To check the temperature in the oven during cooking. Easy cleaning with water and soap.

**Small plastic thermometer - from - 40°C to 40°C**

Code	Designation	Lcm	Wcm	Hcm	Kg
4761.00N	From -40°C to +50°C	13,5	2,4	0,13	0,01



This metric thermometer goes from -40°C to +40°C and is specially adapted for the cold. The thermometer has an all-plastic body. The column is very visible.

**Electronic cooking digital thermometer-timer**

Code	Designation	Lcm	Wcm	Hcm	Th.mm	Kg
4885.00N	Use T° : from -25° to + 250 °C	7	6	1,8	1	0,54



This thermometer has a 1 meter (3 feet)- metal wire. The probe resists to temperatures from 0°C to 250°C. It is used to read the inner temperature of food during cooking. Instant digital readout. The stainless steel probe and wire are heat resistant. Equipped with an automatic alarm sound. There is a magnet for metal surface attachment.

**Digital waterproof thermometer for meat -50°C to +200 °C**

**Thermometer for foie gras and ham- from + 30°C to +100°C**



Code	Designation	Lcm	Kg
4881.00N	L. probe 12 cm	20	0,06

This electronic digital thermometer is helpful for checking the temperature of cooking meat. The probe is pointed and penetrates easily into the meat. Do not use in the oven or in microwave oven.

Code	Designation	Wcm	Liters.	Kg
4882.01	in a protective plastic holder	0,6	24	0,02

**Kit THERMO CONNECT PRO with sensor**

Code	Designation	Lcm	Wcm	Th.mm	Kg
4885.30	Kit THERMO CONNECT PRO : Case and sensor	16,5	15	5	0,15
4885.31	Sensor Thermo Connect Pro	13,5	8,3	6,1	0,05



Thermometer and hygrometer ambient + probe temperature (cable 1.5 meter) with transmission via radio frequency (868 mhz) and internet.  
 Warning, monitoring and temperature recording on mobile.  
 Graphic, transmission via email (csv file).  
 Kit 4885.30 necessary. Do not buy a sensor alone.  
 MEASURING INTERVAL : 3,5 min (except high variation and alert)  
 Range : -40+60°C /20-99%  
 Accuracy : +/-1°C / +/-5% - Sonde +/- 0,5°C  
 Sensor : 2x1,5V AAA not included (1 year)



**Infrared thermometer from -38°C to +365°C.**



Code	Designation	Lcm	Wcm	Kg
4881.10		18,5	8	0,17

AUTO-OFF function . Backlight. Indicates temperature in °C or °F  
 Supplied with a cover for belt.  
 2 batteries 1.5V included.

**Stainless steel mechanical timer with magnet**



Code	Designation	Øcm	Th.mm	Kg
4650.10		6	3,8	0,09

Countdown the remaining time in red.  
 Ringtone strong. It has a magnetic back.

**Electronic stopwatch timer - 20 hours**



Code	Designation	Lcm	Wcm
4650.00N	Timer 20 hours Stopwatch 20 minutes	50	60

This timer is a count down one (up to 19hours and 59 minutes) and is ideal for cooking in order to respect cooking time. It has a magnetic back clip and easel stand. Battery included.

## UTENSILS

### Metal cleaner



Code	Designation	Liters.	Kg	PU
	COPPER cleaner			
<b>4200.01N</b>	150 ml	0,15	0,24	6

This cleaner gives brilliance back to your utensils. It is really easy to use: first, clean your pan. Wet the sponge with hot water and dip it in the cleaner. Rub the whole pan with the sponge. Then rinse it with hot water and dry it carefully.



### Alcohol gel for burning.



Code	Designation	Øcm	Lcm	Wcm	Hcm	Liters.	Kg	PU
<b>4409.02N</b>	Gel alcohol small measure 200 g	8,5			5		0,25	1
<b>4409.52N</b>	Box of 72 measures 200 gr.							1
<b>4409.05N</b>	Gel alcohol 1- liter bottle				23,5	1	1	12
<b>4409.04</b>	Gel alcohol bucket 4 kg	26	18,5				4	4

Safer than liquid methylated spirit, this alcohol gel for burning is odourless and has the same heating power as liquid methylated. This high-heat output alcohol will maintain heat for 3,5 hours per 200g shot. Meets environmental standards. ETHANOL spirit.

### Foodgrade string Rotifil - Heavy duty



Code	Designation	Øcm	Hcm	Kg
<b>4337.01</b>	Set of 10 reels 45 gr Rotifil 2TE ø 0,8mm	6	4,8	0,45
<b>4338.01</b>	Reel 1 kg Rotifil 3TE ø 01,1 mm	10	14	1

High resistance to breaking. Use from -40°C to +220°C. Regular diameter - height - weight. Good whiteness Foodgrade. Suitable for direct contact with foodstuffs in compliance with legislation in force EU 10/2011. Guaranteed without formaldehyde. Slightly absorbent. Can be used in automatic machine. Made in France.

## UTENSILS

### Box of 10 neoprene pairs of handle gloves for thermic protection



Code	Designation	Lcm	Wcm	Hcm	Kg
4636.10	Small size 7 cm	24	14,5	6	0,36
4636.20	Large size 11 cm for	24	14,5	6	0,44

Fits to the handles of stewpan, sauté-pan etc. to handle without any risk of burning

### Box of 10 neoprene handle gloves for thermic protection



Code	Designation	Lcm	Wcm	Hcm	Kg
4636.00		20,5	13	5,5	0,26





de Buyer ®

# MILLS

## De Buyer and the mills

### A spicy story and a challenge taken up with relish

For two centuries, the passion for cookery, taste and Gastronomy, both local and from around the world, has driven de Buyer's manufacturing. Its savoir faire in the design and manufacturing of high-quality kitchen and patisserie utensils responds to the demands of professionals and enthusiasts for all that is good and home-made.

It has thus created its own world dedicated to the mastery of taste, so it is entirely natural that it should wish to complement its collections with mills for salt, pepper and other spices.

However, de Buyer is first and foremost a manufacturer that loves to design, innovate and use its savoir faire and experience to make its products. As a living heritage company, the business has retained its artisanal soul, its rigour and its love for work well done.

De Buyer has always wanted to offer its own collection of mills, bearing its signature.

De Buyer approached Marlux to create this collection. Both companies share the same values, an artisanal soul and a love for work well done. Marlux is a family business, founded in 1875 and is also a living heritage company that has become a major name in the history of French mill manufacturing. In 1972, it revolutionised the world of spices by inventing the nutmeg mill and, as true benchmarks, their mills featured on the finest tables because of the quality of their salt and pepper grinders, manufactured on its own machines.

The great spice adventure began in 2015 for de Buyer and the first mills began to leave the factory in 2016.

The company's mastery of materials enables de Buyer to create mills with new signature mechanisms in steel and ceramic.

Today, the manufacturing process of the mills is part of the de Buyer company's CSR policy: the wooden mills are made of beech from sustainably managed forests and have obtained the Origine France Garantie certification.

Spices are ingredients that are inextricably linked to flavour; masterfully ground, they reveal themselves and enable us all to create our own symphonies of aromas.









# MILL

## MECHANISM

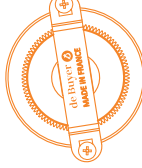
### WOODEN MODELS

### ACRYLIC MODELS

	PEPPER	SALT	NUTMEG	SPICES
Designed for	All types of round peppercorns Not salt	Coarse white salt not wet salt	Nutmeg only	pepper mixes and large peppercorns / seeds, white cooking salt, herbes de Provence, seeds such as cumin, poppy or sesame, fleur de caviar etc...
Type of mechanism	Steel mechanism	Stainless steel mechanism	Stainless steel mechanism	Wide standard mechanism Standard mechanism
Material	High-quality treated hardened steel	18/10 quality stainless steel	18/10 quality stainless steel	Ceramic
Appearance of the mechanism				
Adjustment of the grind	 Top button	 Top button	 Top button	 Lower wheel with 4 settings
Shaft	Nickel-plated steel	Stainless steel	Stainless steel	Aluminium
Guarantee	Lifetime			
Height of the mills (cm)	7 - 10 - 14 - 18 - 21 25 - 30 - 40 - 70	7 - 10 - 14 - 18 - 21 25 - 30 - 40	10	7 - 11 - 14 - 18





## COLLECTION B BOIS

B BOIS mills made of beechwood with a beeswax protective finishing.

'B Bois' products are exclusively sold via physical retailers.



## Spice mills 'B BOIS' BOOGIE 7 cm



Code	Designation	Øcm	Hcm	Kg
	PEPPER MILL			
<b>P292.071111</b>	Steel mechanism	7	9	0,15
	SALT MILL			
<b>S392.071111</b>	St/steel mechanism	7	9	0,15
	SPICE MILL			
<b>C092.071111</b>	Ceramic mechanism	7	9	0,14

Steel pepper mechanism and stainless steel salt mechanism.  
Lifetime warranty for steel mechanism.  
Ceramic mechanism suitable for various spices.  
Certified "ORIGINE FRANCE GARANTIE".

## Spice mills 'B BOIS' RUMBA 14 cm



Code	Designation	Øcm	Hcm	Kg
	PEPPER MILL			
<b>P230.141111</b>	Steel mechanism	4,5	14	0,15
	SALT MILL			
<b>S330.141111</b>	St/steel mechanism	4,5	14	15
	SPICE MILL			
<b>C030.141111</b>	Ceramic mechanism	4,5	14	0,15

Steel pepper mechanism and stainless steel salt mechanism. Certified "ORIGINE FRANCE GARANTIE".  
Lifetime warranty for steel mechanism.  
Ceramic mechanism suitable for various spices.

## Spice mills 'B BOIS' RUMBA 20 cm



Code	Designation	Øcm	Hcm	Kg
	While stocks last			
	PEPPER MILL			
<b>P230.201111</b>	Steel mechanism	6,4	20	0,33
	SALT MILL			
<b>S330.201111</b>	St/steel mechanism	6,4	20	0,33
	SPICE MILL			
<b>C030.201111</b>	Ceramic mechanism	6,4	20	0,33

Steel pepper mechanism and stainless steel salt mechanism.  
Lifetime warranty for steel mechanism.  
Ceramic mechanism suitable for various spices.  
Certified "ORIGINE FRANCE GARANTIE".



Collection  
Java



**JAVA** model is the traditional mill: the wood comes in 4 natural and classical colours according to the models:

**light wood, dark wood, matte white and matte black.**

- Available in pepper mill, salt mill and spices mill from 14 to 25 cm.
- Available in pepper and salt mills from 14 to 40 cm.
- The model 70 cm exists only for pepper with a steel mechanism.

Certified ORIGINE FRANCE GARANTIE.

**Mill JAVA 14 cm**



Code	Designation	Hcm	Kg
	PEPPER MILL		
	STEEL MECHANISM		
P245.140101	Natural	14	0,13
P245.140202	Dark	14	0,13
P245.140303	Matte white	14	0,13
P245.140404	Matte black	14	0,13
	SALT MILL		
	STEEL MECHANISM		
S345.140101	Natural	14	0,12
S345.140202	Dark	14	0,12
S345.140303	Matte white	14	0,12
S345.140404	Matte black	14	0,12
	SPICE MILL		
	CERAMIC MECHANISM		
C045.140101	Natural	14	0,13
C045.140202	Dark	14	0,13
C045.140303	Matte white	14	0,13
C045.140404	Matte black	14	0,13

Classical wooden mill. Ceramic mechanism suitable for various spices.  
 Certified "ORIGINE FRANCE GARANTIE".  
 Steel pepper mechanism and stainless steel salt mechanism.  
 Lifetime warranty.

**Coarse grind pepper mill JAVA STEAK**



Code	Designation	Hcm	Kg
M245.140404	Matte black	14	0,13

Special steel mechanism for pepper mill cracked : larger space between the steel teeth to obtain cracked ground pepper  
 Certified ORIGINE FRANCE GARANTIE.

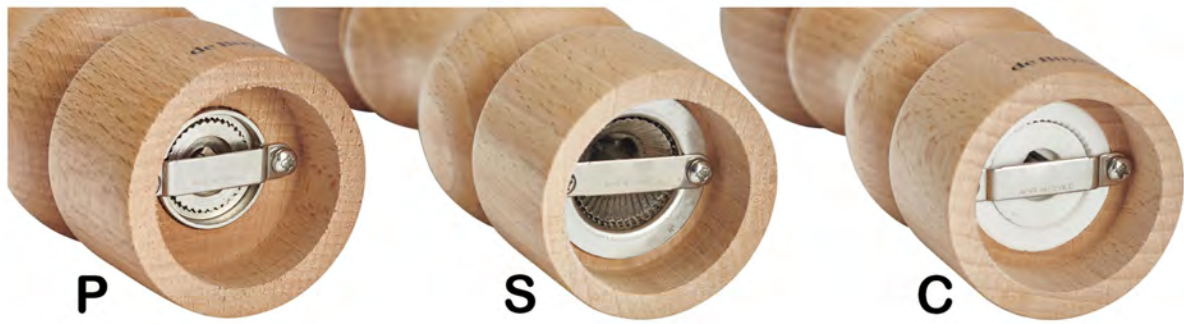

Lacquered mill JAVA 14 cm



Code	Designation	Hcm	Kg
PEPPER MILL			
STEEL MECHANISM			
P245.143131	White	14	0,13
P245.143232	Red	14	0,13
P245.143333	Black	14	0,13
SALT MILL			
STEEL MECHANISM			
S345.143131	White	14	0,12
S345.143232	Red	14	0,12
S345.143333	Black	14	0,12
SPICE MILL			
CERAMIC MECHANISM			
C045.143131	White	14	0,13
C045.143232	Red	14	0,13
C045.143333	Black	14	0,13

Classical wooden mill.  
 Certified "ORIGINE FRANCE GARANTIE".  
 Steel pepper mechanism and stainless steel salt mechanism.  
 Lifetime warranty.  
 Ceramic mechanism suitable for various spices.

This range of classical mills is made of beech wood. The wood is lacquered : one coat of white lacquer then three coats of the color. The glossy lacquered finish and the vibrant shades bring a colourful touch and brighten up the kitchen and table.

Mill JAVA 18 cm



Code	Designation	Hcm	Kg
PEPPER MILL			
STEEL MECHANISM			
P246.180101	Naturel	18	0,2
P246.180202	Dark	18	0,2
P246.180303	Matte white	18	0,2
P246.180404	Matte black	18	0,2
SALT MILL			
STEEL MECHANISM			
S346.180101	Naturel	18	0,2
S346.180202	Dark	18	0,2
S346.180303	Matte white	18	0,2
S346.180404	Matte black	18	0,2
SPICE MILL			
CERAMIC MECHANISM			
C046.180101	Naturel	18	0,2
C046.180202	Dark	18	0,2
C046.180303	Matte white	18	0,2
C046.180404	Matte black	18	0,2

Classical wooden mill.  
 Certified "ORIGINE FRANCE GARANTIE".  
 Steel pepper mechanism and stainless steel salt mechanism.  
 Lifetime warranty.  
 Ceramic mechanism suitable for various spices.



## Mill JAVA 21 cm



Code	Designation	Hcm	Kg
	PEPPER MILL		
	STEEL MECHANISM		
P247.210101	Natural	21	0,24
P247.210202	Dark	21	0,24
P247.210303	Matte white	21	0,24
P247.210404	Matte black	21	0,24
	SALT MILL		
	STEEL MECHANISM		
S347.210101	Natural	21	0,22
S347.210202	Dark	21	0,22
S347.210303	Matte white	21	0,22
S347.210404	Matte black	21	0,22
	SPICE MILL		
	CERAMIC MECHANISM		
C047.210101	Natural	21	0,24
C047.210202	Dark	21	0,24
C047.210303	Matte white	21	0,24
C047.210404	Matte black	21	0,24

Classical wooden mill.  
 Certified "ORIGINE FRANCE GARANTIE".  
 Steel pepper mechanism and stainless steel salt mechanism.  
 Lifetime warranty.  
 Ceramic mechanism suitable for various spices.

## Mill JAVA 25 cm



Code	Designation	Hcm	Kg
	PEPPER MILL		
	STEEL MECHANISM		
P249.250101	Natural	25	0,3
P249.250202	Dark	25	0,3
P249.250303	Matte white	25	0,3
P249.250404	Matte black	25	0,29
	SALT MILL		
	STEEL MECHANISM		
S349.250101	Natural	25	0,27
S349.250202	Dark	25	0,27
S349.250303	Matte white	25	0,27
S349.250404	Matte black	25	0,3
	SPICE MILL		
	CERAMIC MECHANISM		
C049.250101	Natural	25	0,3
C049.250202	Dark	25	0,3
C049.250303	Matte white	25	0,3
C049.250404	Matte black	25	0,3

Classical wooden mill.  
 Certified "ORIGINE FRANCE GARANTIE".  
 Steel pepper mechanism and stainless steel salt mechanism.  
 Lifetime warranty.  
 Ceramic mechanism suitable for various spices.

## Pepper/Salt mill JAVA 30 cm, steel mechanisms



Code	Designation	Hcm	Kg
	PEPPER MILL		
P253.300101	Natural	30	0,56
P253.300202	Dark	30	0,56
P253.300303	Matte white	30	0,56
P253.300404	Matte black	30	0,56
	SALT MILL		
S353.300101	Natural	30	0,56
S353.300202	Dark	30	0,56
S353.300303	Matte white	30	0,56
S353.300404	Matte black	30	0,56

Classical wooden mill. Lifetime warranty.  
 Certified "ORIGINE FRANCE GARANTIE".  
 Steel pepper mechanism and stainless steel salt mechanism.

Pepper/Salt mill JAVA 40 cm, steel mechanisms



Code	Designation	Hcm	Kg
PEPPER MILL			
P251.400101	Natural	40	0,93
P251.400202	Dark	40	0,93
SALT MILL			
S351.400101	Natural	40	0,93
S351.400202	Dark	40	0,89

Classical wooden mill.  
 Steel pepper mechanism and stainless steel salt mechanism.  
 Lifetime warranty.  
 Certified "ORIGINE FRANCE GARANTIE".

Pepper mill JAVA 70 cm



Code	Designation	Hcm	Kg
P256.700101	Natural	70	2
P256.700202	Dark	70	2

Classical wooden mill.  
 Steel pepper mechanism and stainless steel salt mechanism.  
 Lifetime warranty.  
 Certified "ORIGINE FRANCE GARANTIE".



# Collection Rumba



BVCert. 6054661



## Mill RUMBA 14 cm



Code	Designation	Hcm	Kg
	PEPPER MILL		
	STEEL MECHANISM		
P230.140101	Natural	14	0,14
P230.140202	Dark	14	0,14
P230.140303	Matte white	14	0,14
P230.140404	Matte black	14	0,14
	SALT MILL		
	STEEL MECHANISM		
S330.140101	Natural	14	0,14
S330.140202	Dark	14	0,14
S330.140303	Matte white	14	0,14
S330.140404	Black	14	0,14
	SPICE MILL		
	CERAMIC MECHANISM		
C030.140101	Natural	14	0,15
C030.140202	Dark	14	0,15
C030.140303	White matte	14	0,15
C030.140404	Black matte	14	0,15

A mill with pleasant and well-rounded curves. It offers a good grip, is a convenient size and is very handy in the kitchen and on the table.

Classical wooden mill.  
Certified "ORIGINE FRANCE GARANTIE".  
Steel pepper mechanism and stainless steel salt mechanism.  
Lifetime warranty.

Ceramic mechanism suitable for various spices.

## Mill RUMBA 18 cm



Code	Designation	Hcm
	PEPPER MILL	
	STEEL MECHANISM	
P230.180101	Natural	18
P230.180202	Dark	18
P230.180303	White matte	18
P230.180404	Black matte	18
	SALT MILL	
	STEEL MECHANISM	
S330.180101	Natural	18
S330.180202	Dark	18
S330.180303	White matte	18
S330.180404	Black matte	18
	SPICE MILL	
	CERAMIC MECHANISM	
C030.180101	Natural	18
C030.180202	Dark	18
C030.180303	White matte	18
C030.180404	Black matte	18

A mill with pleasant and well-rounded curves. It offers a good grip, is a convenient size and is very handy in the kitchen and on the table.

Steel pepper mechanism and stainless steel salt mechanism.  
Lifetime warranty.

Ceramic mechanism suitable for various spices.

Certified "ORIGINE FRANCE GARANTIE".



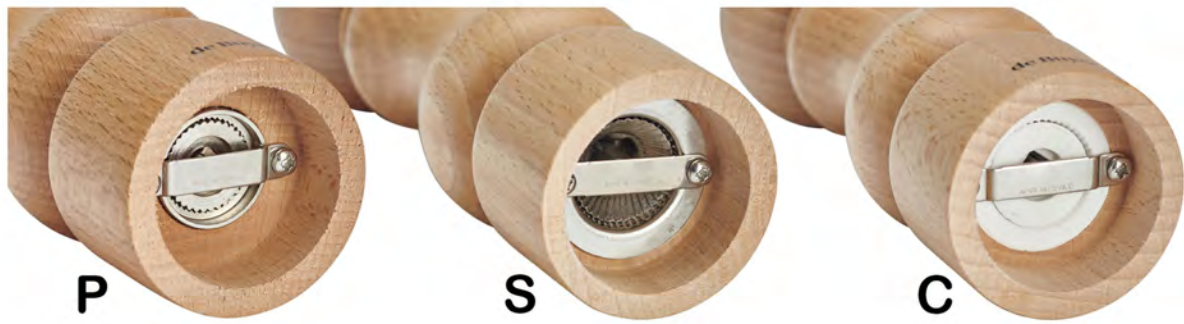

Mill RUMBA 21 cm

new  
2023



Code	Designation	Hcm	Kg
PEPPER MILL			
STEEL MECHANISM			
P230.210101	Natural	21	0,34
P230.210202	Dark	21	0,34
P230.210303	White matte	2023	21 0,34
P230.210404	Black matte	2023	21 0,34
SALT MILL			
STEEL MECHANISM			
S330.210101	Natural	21	0,34
S330.210202	Dark	21	0,34
S330.210303	White matte	2023	21 0,34
S330.210404	Black matte	2023	21 0,34
SPICE MILL			
CERAMIC MECHANISM			
C030.210101	Natural	21	0,35
C030.210202	Dark	21	0,35
C030.210303	White matte	2023	21 0,35
C030.210404	Black matte	2023	21 0,35



A mill with pleasant and well-rounded curves. It offers a good grip, is a convenient size and is very handy in the kitchen and on the table.

Certified "ORIGINE FRANCE GARANTIE".

Steel pepper mechanism and stainless steel salt mechanism. Lifetime warranty.

Ceramic mechanism suitable for various spices.

Pepper/Salt lacquered mill RUMBA 20 cm



Code	Designation	Hcm	Kg
PEPPER MILL			
STEEL MECHANISM			
P230.213232	Red	21	0,34
P230.213333	Black	21	0,34
SALT MILL			
STEEL MECHANISM			
S330.213232	Red	21	0,32
S330.213333	Black	21	0,32
SPICE MILL			
CERAMIC MECHANISM			
C030.213232	Red	21	0,35
C030.213333	Black	21	0,35

Classical wooden mill.  
 Certified "ORIGINE FRANCE GARANTIE".  
 Steel pepper mechanism and stainless steel salt mechanism.  
 Lifetime warranty.  
 Ceramic mechanism suitable for various spices.

This range of classical mills is made of beech wood. The wood is lacquered : one coat of white lacquer then three coats of the color. The glossy lacquered finish and the vitamin shades bring a colourful touch and brighten up the kitchen and table.

# Collection Paso



**Mill PASO 10 cm**



Code	Designation	Hcm	Kg
	PEPPER MILL		
	STEEL MECHANISM		
<b>P240.100101</b>	Natural	10	0,11
<b>P240.100202</b>	Dark	10	0,11
<b>P240.100303</b>	Matte white	10	0,11
<b>P240.100404</b>	Matte black	10	0,11
	SALT MILL		
	STEEL MECHANISM		
<b>S340.100101</b>	Natural	10	0,09
<b>S340.100202</b>	Dark	10	0,09
<b>S340.100303</b>	Matte white	10	0,09
<b>S340.100404</b>	Matte black	10	0,09
	SPICE MILL		
	CERAMIC MECHANISM		
<b>C040.100101</b>	Natural	10	0,11
<b>C040.100202</b>	Dark	10	0,11
<b>C040.100303</b>	Matte white	10	0,11
<b>C040.100404</b>	Matte black	10	0,11

The mini traditional ideal table model. Indispensable and always fashionable.

Classical wooden mill.  
 Certified "ORIGINE FRANCE GARANTIE".  
 Steel pepper mechanism and stainless steel salt mechanism.  
 Lifetime warranty.

Ceramic mechanism suitable for various spices.

**Salt shaker PASO 10 cm**



Code	Designation	Hcm	Kg
<b>M340.100101</b>	Natural	8,8	0,05
<b>M340.100202</b>	Dark	8,8	0,05

The mini traditional ideal table model. Indispensable and always fashionable.



# Collection Manivelle



## Wooden spice mills BOOGIE 7 cm



Code	Designation	Øcm	Hcm	Kg
PEPPER MILL				
Steel mechanism				
<b>P292.070101</b>	Natural	9	7	0,15
<b>P292.070202</b>	Dark	9	7	0,15
SALT MILL				
Stainless steel mechanism				
<b>S392.070101</b>	Natural	9	7	0,15
<b>S392.070202</b>	Dark	9	7	0,15
SPICE MILL				
Ceramic mechanism				
<b>C092.070101</b>	Natural	9	7	0,14
<b>C092.070202</b>	Dark	9	7	0,14

Steel pepper mechanism and stainless steel salt mechanism.  
 Lifetime warranty for steel mechanism.  
 Ceramic mechanism suitable for various spices.  
 Certified "ORIGINE FRANCE GARANTIE".

## Nutmeg mill SOKO with crank st/steel handle

Code	Designation	Hcm	Kg
<b>M516.100101</b>	Natural	10	0,13
<b>M516.100202</b>	Dark	10	0,13



The nutmeg, a specialty MARLUX: this original mill has a mechanism in steel unpublished. The nutmeg is stuck on a spring stem and three large teeth hold it on the sharpened plate. Nutmeg is then easily grated by turning handle.  
 Certified ORIGINE FRANCE GARANTIE.



# Collection Exclusive

## Pepper/Salt mill POGO, steel mechanisms



Code	Designation	Hcm	Kg
<b>P222.110606</b> Pepper mill		11	0,11
<b>S322.110606</b> Salt mill		11	0,09

A pleasant curve and a matt black finish give simplicity and elegance to this little table mill. Steel pepper mechanism and stainless steel salt mechanism. Lifetime warranty. Certified "ORIGINE FRANCE GARANTIE".

## Pepper/Salt mill VALSE, steel mechanisms



Code	Designation	Hcm	Kg
	PEPPER MILL		
<b>P224.110671</b> Matte black		11	0,18
	SALT MILL		
<b>S324.110671</b> Matte black		11	0,16

The mill of the large tables with its wooden body with pleasant curves and its lid in metallic silver polished brightly. Steel pepper mechanism and stainless steel salt mechanism. Lifetime warranty.

## Pepper/Salt mill JOTA, steel mechanisms



Code	Designation	Hcm	Kg
	PEPPER MILL		
<b>P223.120101</b> Natural		12	0,24
<b>P223.120606</b> Ebony		12	0,24
	SALT MILL		
<b>S323.120101</b> Natural		12	0,21
<b>S323.120606</b> Ebony		12	0,21

A cylindrical mill with a sleek design, with its grooved aluminum ring and elegant button inlaid in the lid. For the pepper model, the milling adjustment is done from the bottom with a button provided in the mechanism. Steel pepper mechanism and stainless steel salt mechanism.

Lifetime warranty.  
Certified "ORIGINE FRANCE GARANTIE".







# Collection Hip Hop

## Spices mill HIP HOP 11 cm, ceramic mechanism



Code	Designation	Hcm	Kg
	Delivered without spices		
<b>C086.118301</b>	Natural	11	0,09
<b>C086.118302</b>	Dark	11	0,09

Ceramic mechanism suitable for various spices. This mini table mill with its translucent acrylic shape gives a light impression to the table.

Mill delivered empty without spice.

## Spices lacquered mill HIP HOP 11 cm, ceramic mechanism



Code	Designation	Kg
	Delivered without spices	
<b>C086.118331</b>	White	0,09
<b>C086.118332</b>	Red	0,09
<b>C086.118333</b>	Black	0,09

Ceramic mechanism suitable for various spices. This mini table mill with its translucent acrylic shape gives a light impression to the table and its range of coloured lids adapts to all atmospheres.

## Spices mill HIP HOP 11 cm, ceramic mechanism



Code	Designation	Hcm	Kg
	Delivered without spices		
<b>C086.118383</b>		11	0,09

Ceramic mechanism suitable for various spices. 4 grinding settings with the mill base.



# Collection Transparence

## Spices mill BOOGIE with crank plastic handle



Code	Designation	Lcm	Wcm	Hcm	Kg
	Delivered without spices				
<b>C092.078382</b>				7	0,18
<b>C192.048382</b>	Box of 4 spices mills C092.078382	28	7	9	0,77
	Delivered empty				

Ceramic mechanism suitable for various spices. 4 grinding settings with the mill base.

## Spices mill TANGO 14 cm



Code	Designation	Hcm	Kg
	Delivered without spices		
<b>C087.148383</b>		14	0,18

Ceramic mechanism suitable for various spices. 4 grinding settings with the mill base.

## Spices mill MAMBO 18 cm



Code	Designation	Hcm	Kg
	Delivered without spices		
<b>C084.188383</b>		20	0,23

An original baroque mill for the kitchen or table. It looks modern and light due to its transparency.

Ceramic mechanism suitable for various spices. 4 grinding settings with the mill base.









# PRECISE CUTTING WITH MANDOLINES AND KNIVES

The first mandoline enjoyed great success, for being an innovative product (item, tool) that was quick, precise, easy-to-use, durable (lasting) and safe. All the following conceived mandolines stuck to these essential production criteria. De Buyer mandolines have the “Origine France Garantie” label.

---

- 156 -

Mandoline REVOLUTION

Mandoline VANTAGE

Mandoline VIPER

Mandoline ACCESS

Mandoline SWING PLUS

- 164 -

Mini slicer KOMI

Slicer KOBRA

- 166 -

Corer, tomato slicer







- 168 -

Knives & Sharpeners





# SLICERS

	THE SLICERS			THE COMPACTS			
Collection	La Mandoline REVOLUTION	Vantage	VIPER MANDOLINE	La Mandoline ACCESS	Swing PLUS	KOBRA <sup>19.3</sup>	Komi
							
	2012.01	2017.00	2016.00	2014.00	2015.03 / 2015.23 / 2015.43	2011.01 / 2011.21 / 2011.41	2018.00
Type of cuts :							
• Slices	✓	✓	✓	✓	✓	✓	✓
• Crinkle cut	✓		✓	✓	✓		
• Julienne cuts	✓	✓	✓	✓	✓		✓
	2 - 4 and 10 mm « MASTER » version 2 - 3 - 4 - 5 - 7 and 10 mm	2 - 4 - 7 and 10 mm	4 - 10 mm	4 - 10 mm 2 - 7 mm			2 - 4 mm
• Waffle cuts	✓			✓			
• Cubes, lozenges	✓		✓				
Type of blade		V		Straight		V	35 ° angle
Thickness from (mm)	0 to 10	1 to 10	1 to 8	0 to 10			
Folding rear foot	✓	✓	✓	✓	✓		
Gravity guide + pusher	✓	✓	✓	✓	✓		
Extra long pusher	✓	✓					
Colours					Red, Black, Green	Red, Black	
PCB (packaging unit)	1	1	1	1	1	1	1



SLICING KIT

GRAVITY

A GUIDE FOR CUTTING  
 LONG VEGETABLES - SMALL VEGETABLES  
**QUICKLY, EFFORTLESS**  
**WASTE FREE AND SAFELY**

examples



LONG VEGETABLES



cucumber, carrot, zucchini, long radish...

STRAIGHT OR \*  
 CRINKLED SLICES



SMALL FRUITS & VEGETABLES



cherry tomato, shallot, radish, mushroom...



**fits on the slider of DE  
 BUYER's mandolines**  
*(not for Kobra slicer)*



**2015.84 Kit Gravity**  
 with tube slider and grey insert  
*(delivered without mandoline)*



LA MANDOLINE REVOLUTION



La Mandoline REVOLUTION



Multi-cuts : cubes, losanges, slices, crinkle cuts, Julienne cuts, waffle cuts.  
 Thickness from ultrafine slices to one-centimeter.  
 Professional: made of foodgrade st/steel and polymer composites. Satin polished st/steel.  
 Horizontal double-blade made of high-quality cutlery st/steel. Julienne blades made of heavy duty professional st/steel.  
 SECURE with its protective pusher. Easy to handle.  
 Integrated dice system

Code	Designation	Lcm	Wcm	Hcm	Kg
2012.01	Complete Mandoline with receptable & pusher with 1 double horizontal blade-straight/serrated and 3 Julienne blades 2-4-10 mm	39,5	19,5	14	1,54
	STAINLESS STEEL PUSHER with rotating control system				





**La Mandoline REVOLUTION MASTER with stainless steel pusher**



Code	Designation	Lcm	Wcm	Hcm	Kg
2012.41	Complete Mandoline with receptable & pusher	39,5	19,5	14	2,38
	REVOLUTION MASTER version with : STAINLESS STEEL PUSHER with rotating control system - 6 Julienne blades 2-3-4-5-7-10 mm in their removable storage box - EXTRA-LONG PUSHER - Special coated upper plate - Double horizontal blade - lobe edged - Upper foot with cap				

Same features as the standard model. Improved design and optimum efficiency.  
Supplied with the st/steel round pusher and with one plastic extra-long pusher for long products.  
6 Julienne blades 2-3-4-5-7 and 10 mm in their storage box  
The upper foot is reinforced with st/steel 2 caps.  
Improved slide with the special « pro-slide » coating on the upper plate.



**La Mandoline REVOLUTION : Replacement parts**



Code	Designation	Lcm	Wcm	Kg
2012.56	Rotating control system (slider and pusher)			0,62
2012.57	Slider + st/steel pusher			0,5
2012.55	St/steel pusher alone			0,24
	Long pusher + slider			
2000.97	Suitable for the standard Mandoline Small lower foot/stand	12	11,5	0,12
	For REVOLUTION & REVOLUTION MASTER			
2012.98	Upper foot REVOLUTION MASTER			
2000.89	Set of 2 tightening knobs			

**Slicing kit GRAVITY**



Code	Designation	Øcm	Wcm	Hcm	Kg
2015.84	GRAVITY guide and pusher See page 105	5	10,5	14,5	0,18

A GUIDE FOR CUTTING LONG VEGETABLES & SMALL VEGETABLES QUICKLY, EFFORTLESSLY, WASTE FREE AND SAFELY.  
It fits on the slider of DE BUYER 's mandolines

**La Mandoline REVOLUTION : Replacement parts**



Code	Designation	Lcm	Wcm	Th.mm	Kg
2015.95	Double horizontal blades - with lobed edge	15,5	3,2	0,5	0,03
	JULIENNE blades :				
2012.91	JULIENNE 2 mm - black				0,02
2012.92	JULIENNE 4 mm - red				0,02
2012.93	JULIENNE 10 mm - grey				0,02
2012.94	JULIENNE 3 mm - green				0,02
2012.95	JULIENNE 5 mm - blue				0,02
2012.96	JULIENNE 7 mm - orange				0,02
2012.88	Support for 3 Julienne blades (empty) For Mandoline REVOLUTION standard				0,04
2012.89	Storage box for 7 blades - delivred empty				

LA MANDOLINE VANTAGE



La Mandoline VANTAGE



Code	Designation	Lcm	Wcm	Hcm	Kg
<b>2017.00</b>	Complete Mandoline with slider and pusher - Integrated V-shaped blade - 4 Julienne blades 2-4-7-10 mm - V-shaped blade guard for storage - Storage box for accessories - EXTRA-LONG PUSHER	50	15	20	1,83

V-shaped blade to cut all types of fruit/vegetable even the softest. Total safety thanks to the ergonomic pusher and the slider.  
 Stainless steel frame : robust and resistant.  
 Equipped with 4 V-shaped Julienne blades  
 Minimum space - Folding foot.



La Mandoline VANTAGE - Replacement parts 2017.00



Code	Designation	Kg
<b>2017.91</b>	Julienne 2 mm cut - 41 teeth	0,03
<b>2017.92</b>	Julienne 4 mm cut - 22 teeth	0,03
<b>2017.93</b>	Julienne 7 mm - 14 teeth	0,03
<b>2017.94</b>	Julienne 10 mm - 10 teeth	0,03
<b>2017.89</b>	Plastic storage box (empty)	0,27
<b>2017.59</b>	Pusher	0,13
<b>2017.90</b>	Slider	0,05
<b>2017.86</b>	V-blade guard	0,01



**La Mandoline VANTAGE - Extra long pusher**



Code	Designation	Lcm	Wcm	Hcm	Kg
2017.55	Extra long pusher and slider	17,2	13	6,8	0,27

It is used in place of the round pusher. It is the perfect tool to obtain very long cutting shapes.



**Slicing kit GRAVITY**



Code	Designation	Øcm	Wcm	Hcm	Kg
2015.84	GRAVITY guide and pusher See page 105	5	10,5	14,5	0,18

A GUIDE FOR CUTTING LONG VEGETABLES & SMALL VEGETABLES QUICKLY, EFFORTLESSLY, WASTE FREE AND SAFELY.  
It fits on the slider of DE BUYER 's mandolines





LA MANDOLINE VIPER



VIPER Mandoline



Code	Designation	Lcm	Wcm	Hcm	Kg
2016.00	Complete Mandoline with receptacle & pusher with horizontale blade & 2 Julienne 4 -10 mm	44	18,5	15	1,36

Frame with integrated V-shaped horizontal blade for accurate and easy cutting of all fruits/vegetable.  
 Adjustable slice plate - Thickness from 1 to 8 mm.  
 Knob for fast and precise thickness setting.  
 Two julienne plates - 4 and 10 mm - and their storage box.  
 Large receptacle for vegetables/fruits.

Secure with the ergonomic pusher and slider.  
 Equipped with rotation control system to cut dices and diamonds easily.  
 Compact with its folding rear foot.



Slicing kit GRAVITY



Code	Designation	Øcm	Wcm	Hcm	Kg
2015.84	GRAVITY guide and pusher See page 105	5	10,5	14,5	0,18

A GUIDE FOR CUTTING LONG VEGETABLES & SMALL VEGETABLES QUICKLY, EFFORTLESSLY, WASTE FREE AND SAFELY.  
It fits on the slider of DE BUYER 's mandolines

La Mandoline VIPER: Replacements parts



Code	Designation	Lcm	Wcm	Hcm	Kg
2016.96	Horizontal plate for slices	26	12	0,09	0,18
2016.92	Plate Julienne 4 mm	13,2	9,5	0,12	0,11
2016.94	Plate Julienne 10 mm	14,5	10,8	0,05	0,12

La Mandoline VIPER : Replacement parts



Code	Designation	Lcm	Wcm	Hcm	Kg
2016.59	Ergonomic plastic protective pusher	25,2	12	17,5	0,12
2016.90	Plastic slider	26	12	2,5	0,55





LA MANDOLINE ACCESS



LA MANDOLINE ACCESS Stainless steel



Code	Designation	Lcm	Wcm	Hcm	Kg
2014.00	Complete mandoline with polymer composite pusher	44,5	18	23	1,45
	Delivered with a double horizontal blade blade (straight & serrated) and a double Julienne blade (space 4 and 10 mm)				
	- Easy thickness adjustment				
	- Lobed-edge horizontal blade				
	- Ergonomic pusher				

ROBUST AND PROFESSIONAL : Mandoline made of stainless steel  
 COMPACT - Easy to handle - Double-blades system : one single accessory for 2 uses.  
 Folding upper foot for storage.  
 PRACTICAL : Easy inserting of the blades on the side and easy thickness adjustment mechanism.  
 EFFICIENT : Easy and precise cut.  
 SAFE : Ergonomic pusher for maximum safety  
 Non-skid feet.

MULTICUTS : Includes double horizontal blades (straight and serrated) and Julienne blades (space 4 and 10 mm) to produce many cut styles : Julienne cuts, waffle cut, slice or crinkle cuts.  
 Precise thickness adjustment until 10-mm.



Replacement parts for LA MANDOLINE ACCESS



Code	Designation	Lcm	Wcm	Th.mm	Kg
2015.92	Double Julienne blade - 4 and 10 mm				0,26
2015.93	Double Julienne blade - 2 and 7 mm with storage box for both Julienne blades				0,09
2015.95	Double horizontal blades - with lobed edge	15,5	3,2	0,5	0,03
2017.90	Slider				0,05
2014.59	Pusher				

Easy and precise cut thanks to the blades made of high-quality stainless steel. Double-blades system -one single accessory for 2 uses- :

- Straight blade and serrated blade  
 - Julienne blade 4/10 mm and Julienne blade 2/7 mm

Slicing kit GRAVITY



Code	Designation	Øcm	Wcm	Hcm	Kg
2015.84	GRAVITY guide and pusher See page 105	5	10,5	14,5	0,18

A GUIDE FOR CUTTING LONG VEGETABLES & SMALL VEGETABLES QUICKLY, EFFORTLESSLY, WASTE FREE AND SAFELY.

It fits on the slider of DE BUYER's mandolines



LA MANDOLINE SWING PLUS



BYCert. 6054661



La Mandoline SWING PLUS



**ROBUST AND PROFESSIONAL :** Mandoline made of stainless steel and polymer composite.  
**COMPACT -** Easy to handle - Double-blades system : one single accessory for 2 uses. Folding upper foot for storage.  
**PRACTICAL :** Easy inserting of the blades on the side and easy thickness adjustment mechanism.  
**EFFICIENT :** Easy and precise cut. **SAFE :** Ergonomic pusher for maximum safety - Non-skid feet  
**MULTICUTS :** Includes double horizontal blades (straight and serrated) and Julienne blades (space 4 and 10 mm) to produce many cut styles : Julienne cuts, waffle cut, slice or crinkle cuts. Precise thickness adjustment until 10-mm.

Code	Designation	Lcm	Wcm	Kg
2015.03	Complete mandoline with polymer composite Delivered with a double horizontal blade blade (straight & serrated) and a double Julienne blade (space 4 and 10 mm) Black colour New model : - Easy thickness adjustment - Lobed-edge horizontal blade - Ergonomic pusher	40	20	1,19
2015.23	Green colour	40	20	1,19
2015.43	Red colour	40	20	1,19

Replacement parts for SWING PLUS : pusher and slider



Code	Designation	Kg
2015.59	Plastic pusher	0,22
2015.90	Slider for 2015.59	0,6

Large capacity of the receptacle: more products are cut at a single time. Ergonomic pusher for maximum safety

Accessories for LA MANDOLINE SWING PLUS



Code	Designation	Øcm	Lcm	Wcm	Hcm	Th.mm	Kg
2015.92	Double Julienne blade - 4 and 10 mm						0,26
2015.93	Double Julienne blade - 2 and 7 mm with storage box for both Julienne blades						0,09
2015.95	Double horizontal blades - with lobed edge		15,5	3,2		0,5	0,03
2015.84	GRAVITY guide and pusher See page 105	5		10,5	14,5		0,18

Easy and precise cut thanks to the blades made of high-quality stainless steel. Double-blades system -one single accessory for 2 uses- : - Straight blade and serrated blade - Julienne blade 4/10 mm and Julienne blade 2/7 mm

LA MANDOLINE KOBRA



KOBRA V AXIS

"Click Express" system

adjusts the thickness setting quickly, safely and efficiently

Cuts slices from extra-fine up to 5mm thick

KOBRA V AXIS : Professional fruit and vegetable slicer with pusher

Code	Designation	Lcm	Wcm	Hcm	Kg
2011.01	Complete with pusher - Black	36,5	12,2	8	0,66
2011.41	Complete with pusher - Red	36,5	12,2	8	0,66
SPARE PARTS :					
2011.55	Pusher alone				
2011.90	Kit spare parts Kobra				



- V-shaped blade: the blade penetrates the product easily.
- Optimised cutting angle at 19,3°. Cuts easily and perfectly all fruits and vegetables, even the softest ones (tomatoes, pears, etc.).
- Micro-serration of the blade enables the thinnest cut of fruit/vegetable with skin and preserves their flesh composition.
- PRACTICAL & EASY: easy to adjust the height of the cut: the thumb wheel integrated at the end of the handle allows the adjustment of the thickness up to 5 mm. - St/steel ramp
- COMPACT: the pusher clips on for easy storage.
- SAFE Protective pusher. Silicone moulded anti-sliding ergonomic handle. Anti-skid feet.







**Mini vegetable slicer KOMI**



Code	Designation	Lcm	Wcm	Hcm	Kg
2018.00	Complete vegetable cutter with food guard and 2 Julienne blades 2/4 mm	27	11,2	3,3	0,38
SPARE PARTS :					
2018.90	Pusher				
2018.92	Julienne 2 mm				
2018.93	Julienne 4 mm				
2018.95	Blade				

Accurate and efficient: sharp blade with its 35°-angle.  
 Multicut: slices & Julienne 2 mm/4 mm (0.08/0.15 in.).  
 Quick and easy thickness adjustment.  
 Graduated from 0 up to 5 mm.  
 Equipped with an ergonomic protective food guard made of transparent plastic.  
 Compact storage: integrated Julienne blades storage box & food guard.







**Stainless steel tomato slicer, 5,5 mm thickness**



For 10 slices - 5,5 mm thick.

Serrated blades special for tomatoes. The horizontal cutting action avoids juice loss.

The tomato slicer lets you slice ripe tomatoes but also citrus fruits (lemons, oranges, kiwis,...). Suckers on the feet hold the slicer firmly in place on the worktop during use.

Safe: cover guards prevent anyone touching the blades. 2 ergonomic handles.

Made of all stainless steel: easy cleaning.

Code	Designation	Lcm	Wcm	Hcm	Kg
2005.00	Tomato slicer	42,5	20	18	5,5
2005.10	Set of replacement blades	24,5		7	0,14

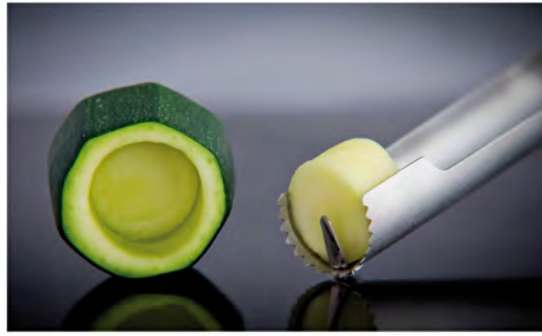

Manual corer for fruits/vegetables - ø12 mm - Orange

Manual corer for fruits/vegetables - ø20mm - Green

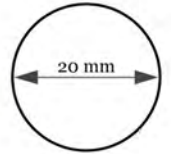

Code	Designation	Øcm	Lcm	Kg
2612.01	L. tube 90 mm - Graduated	2,5	19,7	0,04

Manual extractor that cores and tops and tails fruits/vegetables cleanly in a trice. Patented system. Universal: suitable for various fruits/vegetables.

Multifunctions: removing stalk / Hollowing out / Stuffing. Overmoulded with TPE polypropylene ergonomic anti-slip handle

with hole to hang; Stainless steel blade and graduated tube.

Code	Designation	Øcm	Lcm	Kg
2612.02	L. tube 112 mm - Graduated	3	24,6	0,08

Manual universal corer for fruits / vegetables - ø30 mm - Red

Code	Designation	Lcm	Kg
2612.03	L. tube 112 mm - Graduated	25	0,1

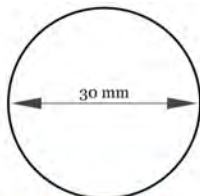

Manual extractor that cores and tops and tails fruits/vegetables cleanly in a trice. Patented system. Universal : suitable for various fruits/vegetables. Multifunctions: removing stalk / Hollowing out / Stuffing.

Overmoulded with TPE polypropylene ergonomic anti-slip handle with hole to hang - Stainless steel blade and graduated tube.

# FK2

The knives FK2 are designed to be the ultimate blend of toughness, sharpness, functionality and value for real working chefs and serious gourmet cooks. In addition to the traditional blades expected, the FK2 range has many innovative blade shapes .



- **HARDNESS** : German X50CrMoV15 stainless steel alloy hardened and tempered to HRC56. Hard for edge retention and tough for edge durability
- **REBALANCE SYSTEM** : find your ideal balance with the innovative adjustable counterweight
- **UNIQUE BLADE GEOMETRY** : a fine grind between the thick German blades and light Japanese blades to bring strength and sharpness together
- **ROBUST HANDLE** : CARBON FIBRE COMPOSITE. Dynamic and ergonomic handle shape with texture grips strongly to resist hand slip
- **SOLID AND STRONG** : thick tang for long term durability. Solid one-piece bolster
- **Made in France**

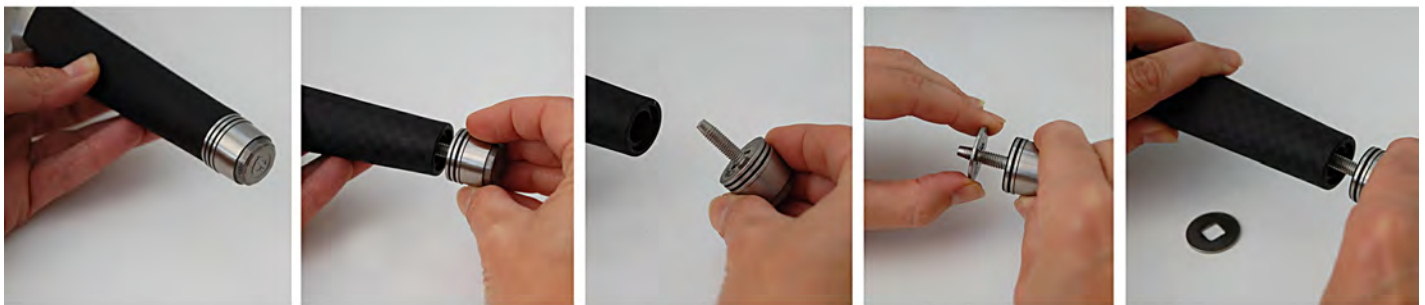

## French Chef 's knife



This knife is the traditional French chef's knife for all heavy cutting work (vegetables, meat and fish).

Code	Designation	Lcm	Wcm	Hcm	Kg
4281.21	L. 21 cm	36	2,2	6	0,28



**Santoku knife L. 17 cm**



**Asian Chef's knife**



Code	Designation	Lcm	Wcm	Hcm	Kg
4281.17		32,4	2,2	5,4	0,26

Good broad range of uses: slicing, chopping of meat and vegetables.

Code	Designation	Lcm	Wcm	Hcm	Kg
4280.15	L. 15 cm	28,6	4,9	2	0,16
4280.17	L. 17 cm	30	5,5	1,8	0,18

This 15cm Asian Chef's knife is very light and sharp and easy to maneuver for light quick cutting tasks in busy kitchens. It is also designed to be ideal for young cooks or for small hands.

**Paring knife L. 9 cm**



Code	Designation	Lcm	Wcm	Hcm	Kg
4282.09		21,7	2	2,3	0,12

Used by chefs for peeling, turning, and other small hand-held jobs.

**Utility knife L. 14 cm**



Code	Designation	Lcm	Wcm	Hcm	Kg
4285.14		26,7	2	3	0,14

Small chopping/slicing knife for many light meat/vegetable jobs for chefs and home cooks.

**Precision carving knife with short and flexible Santoku blade L.16 cm**



Code	Designation	Lcm	Wcm	Kg
4287.16		27,5	2	0,14

Ideally suited for carving thin slices from small pieces of meat and fish with perfect precision.

**Salmon and ham knife Santoku 30 cm**



Code	Designation	Lcm	Wcm	Th.mm
4287.30		42,5	2	2,6

Ultra flexible scalloped blade for cutting thin slices of bacon, ham or salmon.

**Filet knife**



Code	Designation	Lcm	Wcm	Hcm	Kg
4283.16	L. 16 cm	30,9	2,2	2,3	0,2
4283.18	L. 18 cm Perfect for Filet of Sole	28,5			0,14

This knife is perfect to for slicing fillets from fish and chicken. The blade is relatively long, narrow and flexible, for less slicing resistance.

**Boning knife L.13 cm**

Code	Designation	Lcm	Wcm	Hcm	Kg
4284.13	While stocks last	27,8	2,2	1,8	0,19



Specialty boning knife for chefs.

**Carving Knife**



Code	Designation	Lcm	Wcm	Hcm	Kg
4285.26	L. 26 cm While stocks last	40,6	2,2	4	0,28

Traditional western meat slicing blade (with sword tip). This knife is perfect for slicing large roasts, hams, etc. The blade is designed to offer the least resistance when slicing meat , allowing long cuts to be performed easily. It also slices cakes with ease.

**Bread knife**



Code	Designation	Lcm	Wcm	Hcm	Kg
4286.26	L. 26 cm While stocks last	40,5	2,2	3,9	0,28

Bread knife with rounded tooth serration for longer blade life and smoother cutting. This type of serration also makes it a good 'bulk' or rough meat slicer.



**Blade Sharpener TRIUM, 3 levels**



Code	Designation	Lcm	Wcm	Hcm	Kg
4290.02		12	6,7	5,7	0,33

The TRIUM Sharpener was developed to produce very sharp professional cutting edges on any brand of knife. The patent pending Diamond Cams control the edge angle very accurately as you swipe the blade down and back between the cams, for a highly refined cutting edge shape with a perfect hone ever time.

**Professional steel QUINTUM, 5 levels**



Code	Designation	Lcm	Wcm	Kg
4291.00		45	3	0,32
	While stocks last			

The 5-stage professional sharpening and honing centre : the QUINTUM produces sharper knives in less time than traditional methods for better results for chefs and butchers, and easy pro results for home cooks : Diamond Cams in handle for full regrind of worn edges + 4 more stages of finer sharpening on steel shaft, 2 diamond and 2 hard chrome surfaces.

**QUINTUM™**

**Polyethylene cutting board**



Code	Designation	Lcm	Wcm	Hcm	Kg
	Sharp angles				
4920.60N	White	60	40	2	3,9

The polythene cutting board is more hygienic than a wooden board because of the non-porous material.

**Stainless steel cutting board rack for 6 boards**



Code	Designation	Lcm	Wcm	Hcm	Kg
4140.00N	Spacement 3 cm	27	31,5	27,5	1,1

This practical rack lets you stack different cutting boards away or leave them to drain after washing. It lets you easily identify and take the right board.





STAMPED  
TEXT  
IN  
RED  
INK





# PÂTISSERIE: AN ART AND A SCIENCE

When it comes to pâtisserie, you can let your imagination run wild and try out anything that takes your fancy. Our equipment has been developed to guarantee precise results and beautiful aesthetics. We work with leading pastry chefs including winners of the World Pastry Cup and the Meilleur Ouvrier de France competition who help us develop new and innovative utensils that are highly technical and brilliantly performing.

- 176 -

Stainless steel moulds  
Nonstick steel moulds  
Steel moulds

- 189 -

Stainless steel rings

- 200 -

Round trays

- 202 -

Baking supports & trays

- 209 -

Cutters & rolls

- 211 -

Chocolate & sugar work

- 214 -

Nozzles & pastry bags

- 230 -

Pastry accessories







**Box #CAKEDESIGN**



Code	Designation	Lcm	Wcm	Hcm
3989.00		47,5	30	10

Composition:  
 - Stainless steel pastry ring ø 20 cm - Ht 4,5 cm  
 - Confectioners' ribbon Ht 4,5 cm L.10 m - Cold use.  
 - Extra supple reusable pastry bag L. 34 cm  
 - Exclusive set of 6 pastry nozzles with holder  
 (2 plain ø 11/15 mm / St Honoré ø9 mm / 2 Star PF10/PF14 / Square 10 mm)  
 - Nonstick baking paper - roll l. 38 cm x 8 m  
 With recipes from Jonathan Mougel, MOF Pâtissier

**Box #HOMEMADEBREAD**



Code	Designation	Lcm	Wcm	Hcm	Kg
4713.00		47,5	30	10	1,24

Composition:  
 - Baking tray for 2 baguettes, nonstick steel  
 - Rectangular mould, nonstick steel  
 - Baker blade to slit the dough before baking bread  
 - Supple plastic scraper



# Box #homebaking

## Box #HOMEBAKING tarts



Code	Designation	Lcm	Wcm	Hcm	Kg
3030.00		47,5	30	10	1,53

Composition :

- Perforated fluted stainless steel tart ring ø 24 cm
- Round tray made of blue steel ø 28 cm
- Round stainless steel grate with feet ø 28 cm
- Cake server made of stainless steel and beechwood handle

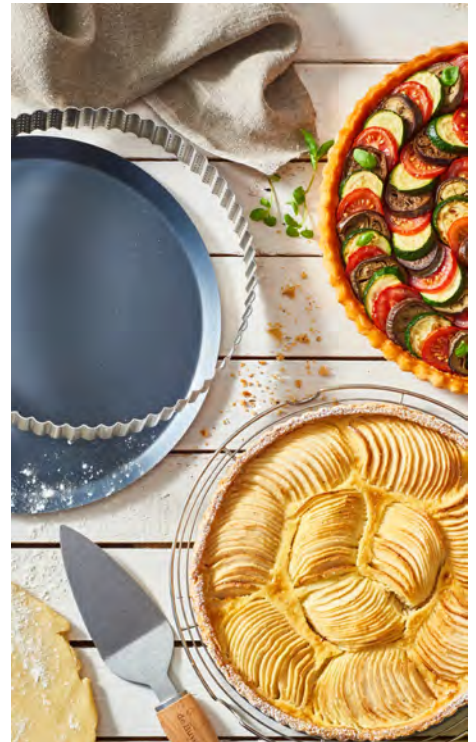

## Box #HOMEBAKING Cakes & tarts



Code	Designation	Lcm	Wcm	Hcm	Kg
4713.03		47,5	30	10	1,56

Composition:

- Square tart mould made of nonstick steel L.23 cm
- Rectangular mould made of nonstick steel
- Square mould made of nonstick steel L.22,5 cm - Ht 5 cm

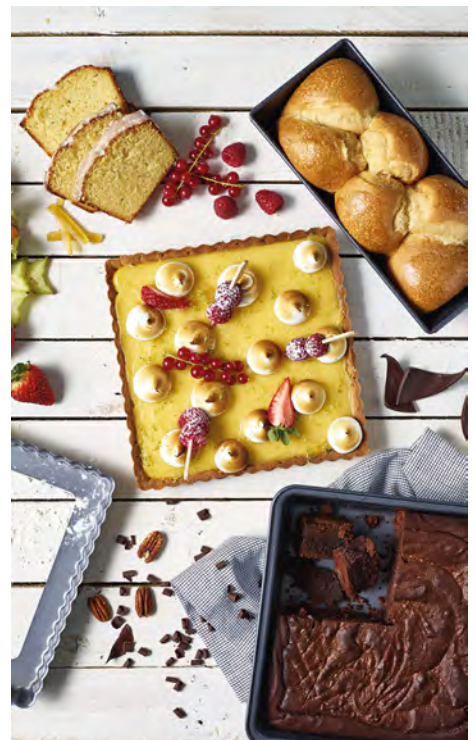



**Jonathan Mougel**

Meilleur Ouvrier de France (MOF) in Pâtisserie and Confectionery, 2019

*"I've used De Buyer products from the very beginning of my career. Their incredible expertise has always satisfied my desire to explore and experiment. We've developed together over time, each sharing the same focus on research and innovation. De Buyer turns my ambitions into reality. Their support has always been unwavering, including when I was awarded the prestigious title of Meilleur Ouvrier de France in Pâtisserie and Confectionery in 2019."*

Jonathan Mougel has come up with recipes for delicious desserts and pâtisseries, using our collection of pastry rings and forms. Discover his creations.



**Tools available for in-store promotion:**

- dedicated packaging
- recipes
- background visuals
- digital kits

**Stainless steel long mould for yule log with removable ends - L. 30 cm**



Code	Designation	Øcm	Lcm	Wcm	Hcm	Kg
3206.30	Round 6,5 cm high	7,5	30		6,5	0,6
3206.04	Round - small size 4 cm high Delivered in decorated box	4	30	4,4	4	0,21
3205.30	Square		30	6,5	6,5	0,66
3205.04	Square - Small size 4 cm Delivered in decorated box		30	4	4	
3204.30	Triangular		30	8	6,5	0,55

Stainless steel long mould to make pâtés and mousses (vegetable, meat or fish), foie gras, ice-creams, Swiss rolls, cream cakes, yule logs, etc.

Tip: the mould becomes waterproof by lining it with cling film before filling.

Our secret : a professional design with thick stainless steel to obtain a mould that keeps its shape and a uniform heat or cold distribution. Smooth surface for an elegant finish. Easy assembly and turning out thanks to the removable end caps and the smooth edges. Multiple uses : cold uses (freezer - deep freezer) and hot uses (oven- bain-marie). Do not use in microwave. Easy care of stainless steel. Dishwasher safe.

The small models can be used alone or in combination with the large standard models to make an insert in your preparation.





**4 supple plastic sheets in relief for cream cake decoration**



Code	Designation	Kg
	For yule log 3206.30	
<b>4343.00</b>	30 x 18,5 cm	0,1
	Delivered in decorated box	

The supple plastic sheet is to place in the mould for rolled-cake or in the pastry frame before making your cream cake. An original relief decoration on the cake is obtained after freezing. 4 patterns are available. No oven cooking. No dishwasher. **MADE IN FRANCE**

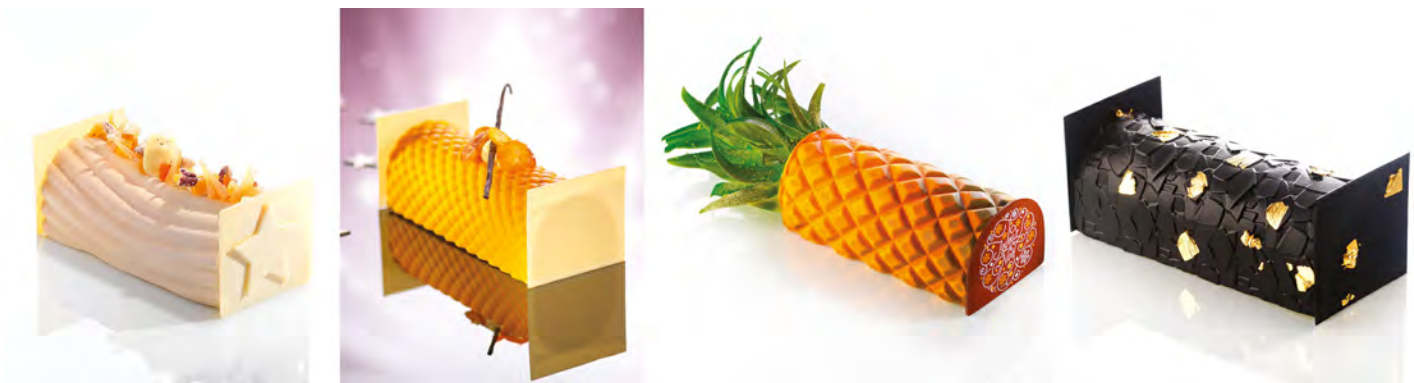

**St. steel long round mould with removable ends - Professional size**



Code	Designation	Lcm	Wcm	Hcm	Th.mm	Kg
<b>3206.80</b>		50	8	6,5	1	0,85



Ideal for making pâtés (with one or two flavours), Yule logs, Swiss rolls, etc. The walls are extra-smooth and turning out is easy. Both end plates are removable.



**FABIEN PAIRON - MOF Charcutier-Traiteur**

Teacher at the hotel school from Lausanne

(Ecole Hôtelière de Lausanne)

M. Pairon imagined, designed and worked on an innovative rectangular mould for "Pâté en Croûte" (meat pie):

- Practical, functional and efficient.
- Easy forming, filling, removal and storage.
- Multiuse : Pâté Croûte (rectangular meat pie), sweet and savory cakes, special breads, ginger bread , etc.
- Developed and manufactured by de Buyer in France.



**Foldable stainless steel rectangular baking mould GEOFORME**

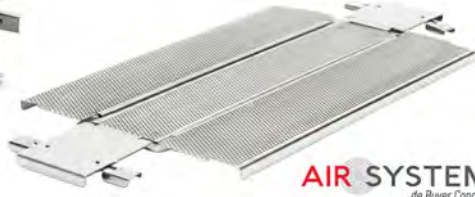

**AIR SYSTEM**  
de Buyer Concept



Code	Designation	Lcm	Wcm	Hcm	Kg
	PERFORATED MODEL - Concept de Buyer AIR SYSTEM				
<b>3210.24</b>	Delivered in decorated box	24	5	6	0,55
<b>3210.35</b>	Delivered in decorated box	35	7	7,5	0,93
<b>3210.48</b>	Professional size only	48	9	8,5	1,28
	BAKING SHEETS (sold separately) :				
<b>4344.21</b>	Baking sheet for 3210.24				
<b>4344.22</b>	Baking sheet for 3210.35				
<b>4344.23</b>	Baking sheet for 3210.48				
	from - 170°C to + 260 °C				

Product developed in collaboration with a professional to design the first foldable mould whose fastening system can not be lost.

The perforated model allows even cooking of the dough.

Perfect for PATE EN CROUTE (meat pies), but also for breads, brioches, ginger breads or cakes.

Can be associated with baking paper for oven cooking.

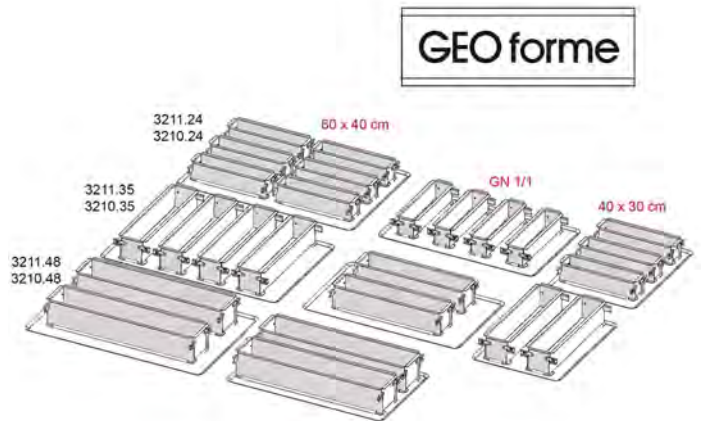
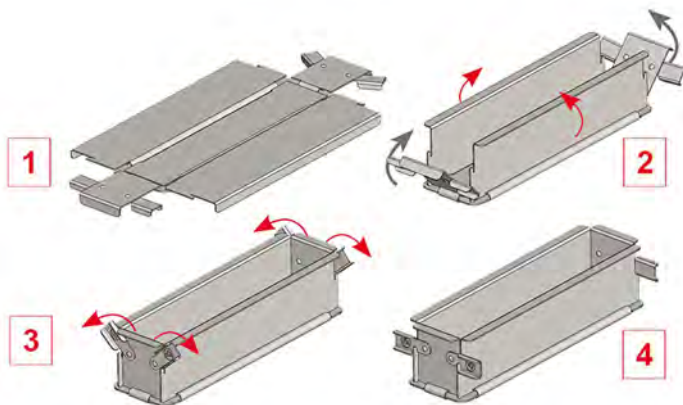

**Ultra resistant stainless steel perforated mould**

Stainless steel perforated molds, heavy duty  
 Suitable for professional and intensive use.  
 Suitable for hot and cold use with no temperature limit.  
 The perforations help cook faster and more evenly without drying the inside:  
 AIR SYSTEM concept: ø2 mm perforations to allow pastry to breathe.

- 15 to 25 % less cooking time,
- for crispy and tasty results,
- for sharp edges and a flawless finish.

Removable bottom: Easy to unmold.

Made in France

Mould supplied with a nonstick baking sheet.  
 Cut to the shape of the mould. Fits perfectly into the mould. Time saving and higher productivity.  
 Reusable over 200 times. Use T° from -76°C to + 260°C (-105° to 500°F)  
 Removable : possible to use the st/steel mould alone or with the baking sheet.



- Cooks to perfection: food is crispy and cooked in the middle
- Scratch-resistant
- Durable and eco-friendly product
- Easy to clean



**Dismontable round mould with 2 nonstick baking sheets**



Code	Designation	Øcm	Hcm	Kg
3213.20		20	7,5	0,5
3213.24		24	7,5	0,69
BAKING SHEETS ALONE:				
4344.60	Set of 2 baking sheets for 3213.20			0,03
4344.61	Set of 2 baking sheets for 3213.24			0,04

Perfect for Cheesecake, Brioches or pies.





Rectangular mould with loose base with 2 baking sheets



Code	Designation	Lcm	Wcm	Hcm	Kg
3212.35		35	10,5	3,5	0,09
BAKING SHEETS ALONE:					
4344.51	Set of 2 baking sheets for 3212.35				0,03

Round fluted tart mould with loose base and 2 nonstick baking sheets



Code	Designation	Øcm	Hcm	Kg
3214.24		24	2,5	0,4
3214.28		28	2,5	0,52
BAKING SHEETS ALONE:				
4344.71	Set of 2 baking sheets for 3214.24			0,02
4344.72	Set of 2 baking sheets for 3214.28			0,03



Rectangular cake mould with loose base and 2 nonstick baking sheets



Code	Designation	Lcm	Wcm	Hcm	Kg
3215.15		15	8,6	7,5	0,31
3215.26		26	8,6	7,5	0,47
BAKING SHEETS (sold separately):					
4344.41	Set of 2 baking sheets for 3215.15				0,02
4344.42	Set of 2 baking sheets for 3215.26				0,03





**JÉRÔME LANGILLIER** MAÎTRE PÂTISSIER

WORLD CHAMPION 2009

International consultant

Member of the Organizing Committee of the World Pastry Cup

Founding member of the International Desserts Academy



**St/steel oblique mould special Cake & baking sheet - Concept Jérôme Langillier**



Code	Designation	Lcm	Wcm	Hcm	Th.mm	Kg
<b>3208.23</b>	Oblique long mould and baking sheet Removable ends	23	5,5	5	0,8	0,34
<b>4344.40</b>	Baking sheet for 3208.23 from - 170°C to + 260 °C	35	15,5			0,01

Mould: Robust. Heavy duty st/steel. Easy to assembly with the removable ends. Nonstick baking sheet made of PTFE-coated glass fiber. 0,13-mm thick. Reusable over 200 times. Fits perfectly into the mould. Cut to the shape of the mould and can be used as a template for pastry. Easy moulding and unmoulding. Time saving and higher productivity.

**St. steel straight "Génoise" mould, watertight**



Code	Designation	Lcm	Wcm	Hcm	Th.mm	Kg
<b>4770.40</b>		40	30	5	1	1,4
<b>4770.53</b>	GN 1/1	53	32	5	1	1,85
<b>4770.60</b>		59	39	5	1	2,53

The straight-sided sponge cake mould is leakproof and lets you make biscuits, flans, rice puddings, etc. Being made from stainless steel, it is perfectly hygienic and easy to keep clean.

**Stainless steel "Bordelais" fluted moulds**



Code	Designation	Øcm	Hcm	Th.mm	Kg
<b>3065.35</b>		3,5	4	0,8	0,03
<b>3065.45</b>		4,5	4,2	0,8	0,04
<b>3065.55</b>		5,5	5,5	0,8	0,06



Copper "Bordelais" fluted moulds



Code	Designation	Øcm	Hcm	Liters.	Th.mm	Kg
TINNED COPPER						
6820.35N		3,5	3,3	0,03	0,8	0,01
6820.45N		4,5	4,2	0,06	1	0,03
6820.55N		5,5	5	0,1	1,2	0,05

These moulds allow to use the traditional method for making Bordeaux's famous crunchy Canelé cakes. The copper ensures perfect heat convection for a good caramelization of the juices and a delicious taste.

Crème-caramel mould "dariole", stainless steel



Code	Designation	Øcm	Hcm	Liters.	Th.mm	Kg	PU
3095.45N		4,8	4	0,05	0,8	0,04	6
3095.55N		5,5	5,1	0,14	0,8	0,06	6
3095.65N		6,4	6	0,18	0,8	0,08	6
3095.80		8	7,6	0,32	0,8	0,12	6

The "Dariol" mould is made from extra-smooth stainless steel for easy turning out; this way, the product has a really nice appearance when turned out. The mould is sturdy and will not distort. The shape is perfect for caramel creams.

Hemispherical dome mould, stainless steel



Code	Designation	Øcm	Hcm	Liters.	Th.mm	Kg	PU
3133.04N		4	2	0,02	1,2	0,02	10
3133.06N		6	2,7	0,05	1	0,03	5
3133.08N		8	4	0,13	1	0,08	5
3133.10N		10	4,8	0,25	1,2	0,13	5
3133.12		12	5,9	0,45	1,2	0,19	3
3133.14N		14	6,7	0,67	1,2	0,24	3
3133.16N		16	8	1	0,8	0,33	3
3133.18N		18	8,7	1,46	1,5	0,37	2
3133.20N		20	10	2,06	1,5	0,45	2

The various pastry ring shapes allow a pastrycook to make cakes which are good-looking and original, enabling him or her to stand out from the crowd. What's more, the original shape of the cream cake is itself decorative and therefore cuts back on decorating time. The st. steel ring keeps its shape throughout its use but is not too thick for good heat convection during cooking.

Professional Charlotte mould, no lid - Stainless steel



Code	Designation	Øcm	Hcm	Liters.	Kg
3125.07		6,7	4,5	0,14	0,07
3125.10		9,7	6	0,4	0,13
3125.16		16	9	1,5	0,36
3125.18		17,7	10	2,1	0,43
3125.20		19,8	11	3	0,52

Glass lid Ref.3429 are suitable to the Charlotte moulds ø 164-16-18-20 cm

The charlotte mould, with its high sides, is ideal for all sorts of preparations: Charlottes, plum duff, aspic jellies, ice-creams... The two handles allow a firm hold for easy turning out. Stainless steel guarantees good heat transmission and easy cleaning. The corresponding lid ref. 3429 or 4112 is sold separately.

**Nonstick steel pastry moulds**

Robust steel for good oven performance  
 Steel thickness suitable for efficient heat conduction and perfect cooking.  
 Nonstick coating guaranteed without PFOA or PFOS. Easy unmoulding and cleaning.



Round fluted tart mould with straight edge

Round fluted tart mould with straight edge - Loose base



Code	Designation	Øcm	Hcm	Th.mm	Kg
4705.20		20	2	0,6	0,18
4705.24		24	2,8	0,6	0,32
4705.28		28	3	0,6	0,43
4705.32		32	3	0,6	0,56

Code	Designation	Øcm	Hcm	Th.mm	Kg
4706.20		19,8	2	0,6	0,21
4706.24		23	2,8	0,6	0,32
4706.28		28	3	0,6	0,47
4706.32		32	3	0,6	0,61

**Round fluted fruit tart mould**



Code	Designation	Øcm	Hcm	Th.mm	Kg
4707.28		28	3	0,4	0,26



Round fluted tart mould with oblique edge

Code	Designation	Øcm	Hcm	Th.mm	Kg
4703.10		10	2	0,4	0,04
4703.12		12	2	0,4	0,05



Rectangular fluted tart mould with loose base



Code	Designation	Lcm	Wcm	Hcm	Th.mm	Kg
4708.20		20	8	2,7	0,6	0,15
4708.36		35,6	10,2	2,7	0,6	0,32

Square fluted tart mould with loose base



Code	Designation	Lcm	Wcm	Hcm	Th.mm	Kg
4709.18		18	18	2,7	0,6	0,25
4709.23		23	23	2,7	0,6	0,41

Charlotte round mould without lid



Code	Designation	Øcm	Hcm	Kg
4719.18		18	10	0,23
3429.18	GLASS LID FOR CHARLOTTE MOULD :	18		0,35

Square pastry mould



Code	Designation	Lcm	Wcm	Hcm
4700.22		22,5	22,5	5



**Round pastry mould**



Code	Designation	Øcm	Hcm	Kg
4718.16		16	5	0,14
4718.20		20	5	0,2
4718.26		26	5	0,3

**Round pastry mould**



Code	Designation	Øcm	Hcm	Th.mm	Kg
4717.20		20	3,7	0,6	0,17
4717.23		23	3,8	0,6	0,21
4717.28		28	5	0,6	0,32

**Brioche fluted mould**



Code	Designation	Øcm	Hcm	Th.mm	Kg
4702.10	Mini brioche mould	10	4,5	0,4	0,05
4702.22		22	8,3	0,4	0,24

**Kougloff mould**



Code	Designation	Øcm	Hcm	Kg
4701.22		22	10	0,29



**Set of 4 "Canelés Bordelais" fluted individual moulds**



Code	Designation	Hcm	Kg
4718.05		5,5	0,16

Rectangular tray of individual pastry moulds



Code	Designation	Lcm	Wcm	Hcm	Th.mm	Kg
4843.00	12 Muffins ø 7 cm Ht 3 cm	38	27	3,5	0,4	0,42
4710.12	12 Madeleines	26	20	1,4	0,4	0,2
4711.12	12 round tarlets ø 7 cm	34	26	1,9	0,4	0,35
4712.06	6 Mini-Savarins ø 8 cm	21,5	31,5	2,2	0,4	0,34
4712.12	12 Mini-Savarins ø 7 cm	34,3	26,2	2,2	0,4	0,4

Round Savarin pastry mould



Code	Designation	Øcm	Kg
4712.24		24	0,41



Dismontable round Savarin pastry mould - 2 bottoms for 2 uses



Code	Designation	Øcm	Kg
4766.26		26	0,55

Dismontable round pastry mould



Code	Designation	Øcm	Hcm	Kg	PU
4844.20		20	6,7	0,27	3
4844.24		24	6,7	0,3	3
4844.26		26	6,7	0,33	3
4844.28		28	6,7	0,36	3





Oven tray with insulating double wall



Code	Designation	Lcm	Wcm	Hcm	Th.mm	Kg
4714.00		35,5	27,5	0,3	0,4	0,68

Double wall : perfect for macaroons and cookies cooking.

Rectangular cake mould with rounded edges



Code	Designation	Lcm	Wcm	Hcm	Th.mm	Kg
4715.15		15	7,5	4,8	0,4	0,1
4715.24		24	13	6,1	0,4	0,23
4715.26		26	10	6,3	0,4	0,21

Rectangular cake mould with folded edges

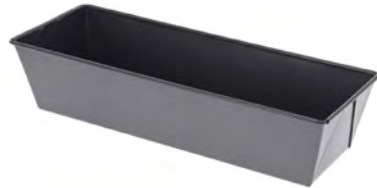

Code	Designation	Lcm	Wcm	Hcm	Th.mm	Kg
4716.25		25	10,8	7	0,3	0,24
4716.30		30	10,8	7	0,3	0,28

Perforated baking tray for 2 baguettes



Code	Designation	Lcm	Wcm	Hcm	Th.mm	Kg
	Concept AIR SYSTEM					
4713.02		37	16,2	2,5	0,6	0,26

Suitable also for giving a rounded shape for chocolate decors or almond tuiles.



**Blue steel pastry moulds**

Robust steel for good oven performance. No coating.  
Steel thickness suitable for efficient heat conduction and perfect cooking.



**Round fluted tartlet mould, blue steel**



Code	Designation	Øcm	Hcm	Th.mm	Kg
5356.09		9	2	0,6	0,05
5356.11		11	2	0,6	0,07
5356.14		14	2	0,6	0,1
5356.17		17	3	0,6	0,16

**Fluted pie pan with loose base, blue steel**



Code	Designation	Øcm	Hcm	Th.mm	Kg	PU
5357.24		24	2,5	0,6	0,34	5
5357.27		26,3	2,5	0,6	0,39	5
5357.30		29,2	2,5	0,6	0,44	5

The high-sided pie tray is ideal for making all kinds of quiches and tarts. Steel plate is a very good heat conductor and lets you make crusty pie pastries. The model with loose base is easy to use as it allows problem-free removal.

**Rectangular cake mould , blue steel**



Code	Designation	Lcm	Wcm	Hcm	Th.mm	Kg
5359.26		9	26	11	0,6	0,37

**Baking fluted mould for "Tuile" and bread, blue steel**



Code	Designation	Lcm	Wcm	Kg
5358.35		35	14	0,31

Suitable also for giving a rounded shape for chocolate decors or almond tuiles.





Concept AIR SYSTEM

The perforations allow the dough to breathe. They guarantee faster and more homogeneous cooking without drying out the filling :

- clean edges and beautiful look
- for a crispy and delicious result



Créations Jonathan Mougel, MOF Pâtissier-Confiseur 2019

Perforated stainless steel tart ring with straight edge - ROUND



Code	Designation	Øcm	Hcm	Kg
HEIGHT 2 CM				
3099.01	4,7 cl	5,5	2	0,02
3099.02	6,6 cl	6,5	2	0,02
3099.03	8,8 cl	7,5	2	0,03
3099.00	11,3 cl	8,5	2	0,03
3099.04	17,3 cl	10,5	2	0,04
3099.05	24,5 cl	12,5	2	0,04
3099.06	37,7 cl	15,5	2	0,05
3099.07	53,7 cl	18,5	2	0,07
3099.08	66 cl	20,5	2	0,08
3099.09	94, 2 cl	24,5	2	0,1
3099.10	127,6 cl	28,5	2	0,12
HEIGHT 3,5 CM				
3098.01		5,5	3,5	0,04
3098.02		6,5	3,5	0,04
3098.03		7,5	3,5	0,05
3098.00		8,5	3,5	0,06
3098.04		10,5	3,5	0,07
3098.05		12,5	3,5	0,08
3098.06		15,5	3,5	0,1
3098.07		18,5	3,5	0,12
3098.08		20,5	3,5	0,13
3098.09		24,5	3,5	0,15
3098.10		28,5	3,5	0,18
3006.01	Pusher for round ring ø 7.5 - 8 cm	7,4	6,1	0,05

Created in partnership with the "Ecole Valrhona", these new tart rings with small holes enable an uniform baking of the pie/tart edges. The straight edge allows an easy removal and a perfect pastry rim.





**Perforated stainless steel tart ring with straight edge - SQUARE**



Code	Designation	Lcm	Wcm	Hcm	Kg
	HEIGHT 2 CM				
3099.19	Perforated indiv. 10 cl	7	7	2	0,04
3099.20	Perforated indiv. 20 cl	8	8	2	0,05
3099.21	40 cl	15	15	2	0,12
3099.23	60 cl	17,5	17,5	2	0,13
3099.22	80 cl	20	20	2	0,15
3006.02	Pusher for square pastry form 8 cm	7,7		6,1	0,04

Created in partnership with the "Ecole Valrhona", these new tart rings with small holes enable an uniform baking of the pie/tart edges. The right edge allows an easy removal and a perfect pastry rim.

**Perforated stainless steel tart ring with straight edge - HEART**



Code	Designation	Øcm	Hcm	Kg
3099.50	9,5 cl - individual	8	2	0,03
3099.51	20 cl - 2 p.	12	2	0,05
3099.52	40 cl - 4 p.	18	2	0,08
3099.53	60 cl - 6 p.	22	2	0,1

**Perforated stainless steel tart ring with straight edge - RECTANGLE**



Code	Designation	Lcm	Wcm	Hcm	Kg
	HEIGHT 2 CM				
3099.30	10 cl - individual	12	4	2	0,09
3099.32	40 cl - 4 p.	25	8	2	0,1
3099.33	60 cl - 6 p.	28	11	2	0,12
	HEIGHT 3,5 CM				
3098.30		12	4	3,5	0,07

Created in partnership with the "Ecole Valrhona", these new tart rings with small holes enable an uniform baking of the pie/tart edges. The right edge allows an easy removal and a perfect pastry rim.



**Perforated stainless steel tart ring with straight edge - OBLONG**



Code	Designation	Lcm	Wcm	Hcm	Kg
3099.40	9,3 cl - individual	14,5	3,5	2	0,06
3006.04	Pusher for oblong rings L. 14 cm	14	3,2	6,1	0,03
3099.42	40 cl - 4 p.	27	8	2	0,09
3099.43	60 cl- 6 p.	30	11	2	0,1



**Perforated stainless steel tart ring with straight edge- CALISSON**



Code	Designation	Lcm	Wcm	Hcm
3099.70	10 cl - Individual ring	12	5	2
3099.72	20 cl - 2 p.	18	7,8	2
3099.73	40 cl - 4 p.	25,5	11	2

**Perforated stainless steel tart ring with straight edge - HEXAGONAL**



Code	Designation	Lcm	Wcm	Hcm	Kg
In partnership with the "Ecole Valrhona"					
3099.60		11	11	2	0,04

Created in partnership with the "Ecole Valrhona", these new tart rings with small holes enable an uniform baking of the pie/tart edges. The right edge allows an easy removal and a perfect pastry rim.



**Perforated fluted stainless steel tart ring with straight edge**



Code	Designation	Øcm	Lcm	Wcm	Hcm
ROUND					
3030.20		20			3
3030.24		24			3
3030.28		28			3
3030.32		32			3
SQUARE					
3031.23			23	23	3
RECTANGULAR					
3032.35			35	10	3

CONCEPT AIR SYSTEM

**Perforated tart ring, rolled edge, height 2 cm**



Code	Designation	Øcm	Hcm	Th.mm	Kg
3093.06		6	2	0,4	0,02
3093.08		8	2	0,4	0,03
3006.01	Pusher for round ring ø 7.5 - 8 cm	7,4	6,1		0,05
3093.10		10	2	0,4	0,04
3093.22		22	2	0,4	0,1
3093.24		24	2	0,4	0,11
3093.26		26	2	0,4	0,12
3093.28		28	2	0,4	0,13



These perforated rings are mainly designed for making pies and tarts. The pie ring is easier to use than a mould because it takes up less space on a baking plate and it's easy to turn out. Concept de Buyer AIR SYSTEM: the holes around the ring enables to suppress air bubbles to obtain a perfect crusty-baked tart.



Tart ring, rolled edge, height 2 cm



Code	Designation	Øcm	Hcm	Th.mm	Kg
3091.06N		6	2	0,4	0,02
3091.07N		7	2	0,4	0,02
3091.08N		8	2	0,4	0,03
3091.10N		10	2	0,4	0,04
3091.12N		12	2	0,4	0,04
3091.14N		14	2	0,4	0,05
3091.16N		16	2	0,4	0,06
3091.18N		18	2	0,4	0,07
3091.20N		20	2	0,4	0,08
3091.22N		22	2	0,4	0,09
3091.24N		24	2	0,4	0,1
3091.26N		26	2	0,4	0,11
3091.28N		28	2	0,4	0,12
3091.30N		30	2	0,4	0,13
3091.32N		32	2	0,4	0,14

These stainless steel rings, 2cm high (3/4"), are mainly designed for making pies and tarts. The pie ring is easier to use than a mould because it takes up less space on a baking plate (several rings can be positioned on the same tray). Apart from that, it's easy to turn out.

Stainless steel round ring, height 4,5 cm



Code	Designation	Øcm	Hcm	Th.mm	Kg	PU
3989.05		5	4,5	0,8	0,04	6
3989.06		6	4,5	0,8	0,05	6
3989.65		6,5	4,5	0,8	0,06	1
3989.07		7	4,5	0,8	0,06	6
3989.75		7,5	4,5	0,8	0,07	6
3989.08		8	4,5	0,8	0,08	6
3006.01	Pusher for round ring ø 7.5 - 8 cm	7,4	6,1		0,05	1
3989.10		10	4,5	0,8	0,09	1
3989.12		12	4,5	0,8	0,11	1
3989.14		14	4,5	0,8	0,12	1
3989.16		16	4,5	1	0,18	1
3989.18		18	4,5	1	0,2	1
3989.20		20	4,5	1	0,22	1
3989.22		22	4,5	1	0,24	1
3989.24		24	4,5	1	0,27	1
3989.26		26	4,5	1	0,29	1
3989.28		28	4,5	1,2	0,36	1

The 4,5 cm high (1-3/4") pastry rings are perfect for mousse-based desserts that have a Joconde biscuit bottom.

Stainless steel round standard - height 6 cm



Code	Designation	Øcm	Hcm	Th.mm	Kg
3940.12		12	6	0,8	0,14
3940.14		14	6	0,8	0,16
3940.16		16	6	1	0,23
3940.18		18	6	1	0,26
3940.20		20	6	1	0,29
3940.22		22	6	1	0,32
3940.24		24	6	1	0,35
3940.26		26	6	1	0,39
3940.28		28	6	1,2	0,4
3940.30		30	6	1,2	0,51

The 6cm high (2-1/2") pastry rings are perfect for vacherins, among other things.



St/steel round high ring -for "PAIN SURPRISE", Panettone, Wedding cakes

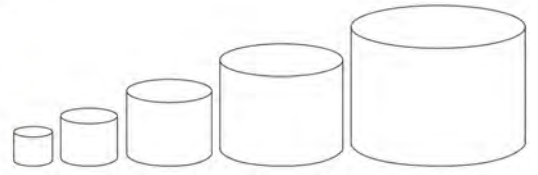

Code	Designation	Øcm	Hcm	Th.mm	Kg
3912.08	30 cl	8	6	1	0,12
3912.12	90 cl	12	8	1	0,23
3912.16	200 cl	16	10	1	0,39
3912.20	380 cl	20	12	1	0,59
3912.24	630 cl	24	14	1	0,82



Perfect for baking Pain Surprise, Panettone or wedding cakes. Suitable for oven cooking and freezing. To combine with baking paper or baking nonstick sheets. Robust and undistortable.



Stainless steel extensible rings



Code	Designation	Hcm	Th.mm	Kg
3040.03	from ø 18 to 36 cm - Graduated Perfect for tarts - 3 cm high	3	0,8	0,15
3040.01	from ø 18 to 36 cm - Graduated	4,5	0,8	0,27
3040.02	from ø 18 to 36 cm - Graduated	6,5	0,8	0,37

Simple and safe adjustment : graduated, clear size markings on the frame.  
Robust and undistortable. Durable product. Lifetime warranty.  
Neat results: the smooth inner parts enable easy removal without any mark on the preparations.

Cold use (freezer - deep freezer) and hot use (traditional oven). Do not use in microwave.  
Easy cleaning: hand washing and dishwasher safe.







**Stainless steel expandable rectangular frame**



Code	Designation	Lcm	Wcm	Hcm	Th.mm	Kg
3013.21	Exp.to maxi. 40x21cm 10-12 p. => 22-24 p. Delivered in decorated box	21,5	11,5	7,5	1	1,07
3013.43	Exp.to maxi. 56 x84cm	43	29	5	1	1,29

Simple and safe adjustment : clear size markings on the frame. Firm and secure interlocking. Perfect maintaining in position during use. Robust and undistortable. Durable product. Lifetime warranty. Neat results : the smooth inner parts enable easy removal without any mark on the preparations.

Cold use (freezer - deep freezer) and hot use (traditional oven). The frame becomes waterproof on a flat surface when it is put on a silicone mat. Easy cleaning and storage: can be dismantled, hand washing and dishwasher safe.

**Stainless steel expandable square frame**



Code	Designation	Lcm	Wcm	Hcm	Th.mm	Kg
3013.16	Max. size 30x30 cm 6-8 p. => 20-22 p. Delivered in decorated box	16	16	5	1	0,57
3013.20	Max. size 37x37 cm Perfect for trays 40x30cm 8-10 p. => 30-32 p. Delivered in decorated box	20	20	5	1	0,69
3013.30	Max. size 5 x57 cm	30	30	5	1	0,82



**Pastry frame, stainless steel**



Code	Designation	Lcm	Wcm	Hcm	Th.mm	Kg
3015.36	For tray 40x 30 cm	36	26	4,5	2,5	1,1
3015.49	For GN 1/1 size	49	29	4,5	2,5	
3015.35		57	37	3,5	2,5	1,12
3015.45		57	37	4,5	2,5	1,6

These stainless steel biscuit frames are extra thick and will not distort. The are easy to keep clean.



**Stainless steel square rings, height 4,5 cm**



Code	Designation	Lcm	Wcm	Hcm	Th.mm	Kg
3906.08	Small square Ht 4,5 cm	8	8	4,5	0,8	0,1
3006.02	Pusher for square pastry form 8 cm	7,7		6,1		0,04
3906.12		12	12	4,5	1	0,17
3906.16		16	16	4,5	1	0,24
3906.20		20	20	4,5	1	0,29
3906.24		24	24	4,5	1,2	0,42
3906.28		28	28	4,5	1,2	0,49

**Stainless steel square rings, height 2 cm**



Code	Designation	Lcm	Wcm	Hcm	Th.mm	Kg
3905.08	Small square Ht 2 cm	8	8	2	1	0,05
3006.02	Pusher for square pastry form 8 cm	7,7		6,1		0,04
3905.12		12	12	2	1	0,08
3905.16		16	16	2	1,2	0,19
3905.20		20	20	2	1,2	0,16
3905.24		24	24	2	1,2	0,19
3905.28		28	28	2	1,2	0,21

CUSTOMIZATION Consult us for your made-to-measure rings

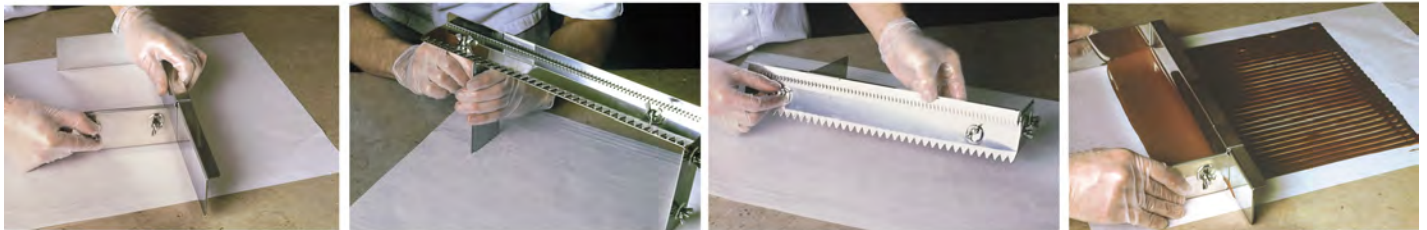

**St. steel "raplette" spreader - Adjustable in width and height**



Code	Designation	Lcm	Wcm	Hcm	Th.mm	Kg
3002.01	Equipped with removable decorating double comb	40	17	6	1,5	0,92
3002.00	Without decorating double comb	40	17	6	1,5	0,91
3002.99	Decorating double comb with teeth Removable - with 2 different shapes	40			1,5	0,22

The Pascal spreader lets you spread out cream or chocolate with a single action. A special feature is its adjustable width and height. These allow you to make very thin layers. Use it with or without its detachable cream-comb teeth. The cream-comb has two different triangular tooth spacings. The spreader is also handy for preparing chocolate shavings.

**Stainless steel heart-shaped ring**



Code	Designation	Øcm	Hcm	Th.mm	Kg	PU
	HEIGHT 40 mm					
<b>3077.06</b>	Heart ø 6 cm	6	4	0,8	0,06	6
<b>3077.14</b>	Equivalent to a 14 cm ring	14	4	1	0,16	1
<b>3077.16</b>	Equivalent to a 16 cm ring	16	4	1	0,18	1
<b>3077.18</b>	Equivalent to a 18 cm ring	18	4	1	0,19	1
<b>3077.22</b>	Equivalent to a 22 cm ring	22	4	1	0,23	1
<b>3077.20</b>	Equivalent to a 20 cm ring	20	4	1	0,22	1
<b>3077.24</b>	Equivalent to a 24 cm ring	24	4	1	0,24	1

The heart form lets you make cakes, ice-cream, or other desserts with an original shape that's perfect for birthdays, Mother's Day, and of course, Saint Valentine's day.

**Plastic confectioner's ribbon (200 m) - 150 microns - Professional size**

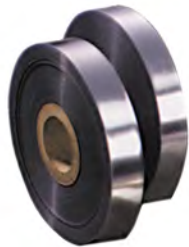

Code	Designation	Hcm	Kg
<b>042002</b>	40 mm high	4	1,65
<b>042003</b>	45 mm high	4,5	1,8
<b>042004</b>	50 mm high	5	2,14
<b>042005</b>	60 mm high	6	2,17

Cake-moulding tapes let you line the insides of pastry rings before moulding cream cakes in them. They then make it easy to turn out the frozen cake without damaging the exterior.

**Polypropylene precut sheets - 60 microns - Professional size**



Code	Designation	Lcm	Hcm	Kg
<b>042011</b>	For cakes ø 65 mm and Ht 40 mm 500 sheets	21,5	4	0,23

The transparent polypropylene sheet is for lining cake moulds in order to ensure easy turning out after cream cakes have been chilled. These pre-cut linings match the Fab'Rapid shapes or other individual rings and allow even better productivity.

**Polypropylene confectioners' ribbon - 60 microns**



Code	Designation	Øcm	Lcm	Wcm	Hcm	Kg
	Set of 100 strips					
<b>042016</b>	For lining cakes until max. ø8cm Delivered in decorated box		27	4,5		0,06
	10-meter roll					
<b>042024</b>	Ht 45 mm	5,2			4,5	0,03
<b>042026</b>	Ht 60 mm	5,2			6	0,04

The transparent polypropylene sheet is for lining cake moulds in order to ensure easy turning out after cream cakes have been chilled.



**Stainless steel oblong individual ring**



Code	Designation	Lcm	Wcm	Hcm	Th.mm	Kg
	CREATION MATHIEU BLANDIN World pastry champion 2013					
<b>3037.14</b>	Oblong Mathieu Blandin In partnership with the "Ecole Valrhona"	14,5	3,5	2	1	0,06
<b>3099.40</b>	Perforated st/steel ring with straight edge 9,3 cl - individual	14,5	3,5	2		0,06
<b>3006.04</b>	Pusher for oblong rings L. 14 cm	14	3,2	6,1		0,03

**Stainless steel rectangular ring, sharp corners**



Code	Designation	Lcm	Wcm	Hcm	Th.mm	Kg
<b>3943.08</b>		8	2,5	2,5	1,2	0,03
<b>3943.10</b>		10	2,5	3	1,2	0,04
<b>3943.11</b>	Rectangular ring	11,5	4	1,7		0,09
<b>3943.12</b>		12	4	3	1,2	0,09
<b>3943.13</b>		12	4	4	1,2	0,12
<b>3942.16</b>		16	3	2,5	1,2	0,09
<b>3941.18</b>		18	3	2	1,2	0,08

This shape of mould is especially well suited for arranging fillings on a dish: for coating cooked vegetables, rice, vegetarian lasagne, or adding a touch of elegance to dishes such as salmon tartare.

**Stainless steel small square individual ring & pusher**



Code	Designation	Lcm	Wcm	Hcm	Th.mm	Kg
<b>3906.08</b>	Small square Ht 4,5 cm	8	8	4,5	0,8	0,1
<b>3905.08</b>	Small square Ht 2 cm	8	8	2	1	0,05
<b>3099.20</b>	Perforated indiv. 20 cl	8	8	2		0,05
<b>3006.02</b>	Pusher for square pastry form 8 cm	7,7		6,1		0,04

**Stainless steel small individual ring**



Code	Designation	Øcm	Lcm	Wcm	Hcm	Th.mm	Kg	PU
<b>3938.40</b>	Round ø 60 - Ht 40 mm	6			4	0,8	0,05	6
<b>3939.06</b>	Round ø 65 - Ht 40 mm	6,5			4	0,8	0,05	6
<b>3096.01</b>	Round ø 45 - Ht 25 mm	4,5			2,5	0,8	0,02	6
<b>3069.06</b>	Ovale equivalent to a ø 60 mm ring		8	5,5	4,5	0,8	0,04	6
<b>3037.06</b>	Oblong equivalent to a ø 60 mm ring		7,4	3,3	4,5	0,8	0,04	6
<b>3037.07</b>	Oblong equivalent to a ø 70 mm ring		8,8	5,2	4,5	0,8	0,05	6
<b>3037.14</b>	Oblong Mathieu Blandin		14,5	3,5	2	1	0,06	1



**Stainless steel small individual pastry ring**



Code	Designation	Øcm	Lcm	Wcm	Hcm	Th.mm	Kg	PU
3937.08	small cake = ring ø7,5 cm		9,4		4,5	0,8	0,08	6
3077.06	Heart ø 6 cm	6			4	0,8	0,06	6
3139.06	Small indiv. square ring, rounded angles		6	6	4	0,8	0,05	6
3027.08	Individual	8	5	4	0,8	0,05	6	

The individual shapes are made of stainless steel and used to make small cakes, mousses, individual cream cakes.

**Stainless steel pastry form "Calisson"**



Code	Designation	Lcm	Wcm	Hcm	Liters.	Th.mm	Kg	PU
INDIVIDUAL :								
3076.11	"Calisson" shaped ring L.11 cm	11	5	4	0,15	0,8		6
MIGNARDISE:								
3076.05	"Calisson" shaped ring L.5,5 cm	5,5	2,5			0,8	0,02	1

**Stainless steel pusher for individual pastry rings and forms**



Code	Designation	Øcm	Lcm	Wcm	Hcm	Kg
3006.01	Pusher for round ring ø 7.5 - 8 cm	7,4			6,1	0,05
3006.02	Pusher for square pastry form 8 cm		7,7		6,1	0,04
3006.04	Pusher for oblong rings L. 14 cm		14	3,2	6,1	0,03



**Round pizza tray, heavy blue steel**



Code	Designation	Øcm	Th.mm	Kg	PU
5350.20		20	1	0,26	5
5350.24		24	1	0,37	5
5350.26		26	1	0,43	5
5350.28		28	1	0,52	5
5350.32		32	1	0,65	5
5350.36		36	1,2	1	5
5350.40		40	1,5	1,2	5

This round tray with flared edges is made of blue steel plate, 1.0mm to 1.5mm thick (16-20 gauge) according to diameter. The plaque will not distort and ensures good heat transmission. This steel plate has a high-quality surface that will not stain pastry bottoms; it is micro-roughened, creating an air mattress between the food to be cooked and the metal. Ideal for pizzas.

**Perforated pizza tray, heavy blue steel - Holes ø 10 mm**



**AIR SYSTEM**  
de Buyer Concept

Code	Designation	Øcm	Kg	PU
Concept AIR SYSTEM				
5353.24		24	0,32	5
5353.28		28	0,45	5
5353.32		32	0,59	5

Thickness 1 mm



**Round pierced pizza tray, aluminium - Hole ø 10 mm**



**AIR SYSTEM**  
de Buyer Concept

Code	Designation	Øcm	Hcm	Th.mm	Kg	PU
Concept AIR SYSTEM						
7366.24		24	0,7	1	0,11	5
7366.28		28	0,7	1	0,15	5
7366.32		32	0,7	1	0,2	5

The low-profile pie tray with its slightly raised edges is perfect for making pizzas, flammenkuche savory tarts, etc. The bottom is perforated to enable you to obtain a crusty-baked pie bottom.

**Non-stick aluminium round tray "CHOC"**



Code	Designation	Øcm	Hcm	Th.mm	Kg
8136.28	Round pizza tray	28	1	2,3	0,41

This round aluminium PTFE-coated plate is completely non-stick, tough, and easy to keep clean. The edge is slightly raised to prevent the mixture from spilling over into the oven during cooking.

**Non-stick aluminium perforated round tray "CHOC"**

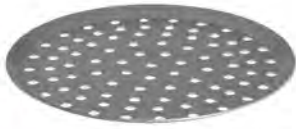

Code	Designation	Øcm	Th.mm	Kg
Concept AIR SYSTEM				
8137.28		28	2,3	0,36

The non-stick pie tray with its slightly raised edges is perfect for making pizzas, flammenkuche savory tarts, etc. The bottom is perforated to enable you to obtain a crusty-baked pie bottom. Easy to clean.



**Mould for upside down pie "Tatin", non-stick cast aluminium CHOC EXTREME Induction**



Code	Designation	Øcm	Hcm	Bottom ø cm	Kg
8320.24	4/6 p.	24	5	16	0,82
8320.28	6/8 p.	28	5,5	18,5	1,2

This mould proves ideal for Tatin tarts, since it allows you to form a caramel layer directly in the mould while it's on the heat. Once the caramel is formed in the mould, just add the apple slices, cover with pastry, and place the mould in the oven. Pressure cast aluminium is ideal for providing regular cooking conditions and the thick bottom stands up excellently to deformation.



**Round stainless steel grate with feet**



Code	Designation	Øcm	Hcm	Kg
0237.28		28	1,5	0,15
0237.32		32	1,7	0,23



# Pastry

## USER GUIDE

### BAKING TRAYS

MATERIALS	BLUE STEEL					ALUMINIUM					NON-STICK ALUMINIUM				STAINLESS STEEL				
	Rectangular tray		Round tray	Special tray for baguettes		Rectangular tray			Round tray, grate		Rectangular tray		Round tray		Rectangular tray			Special tray for baguettes	
Article code	5320.53	5321	5350	5353	5358.35	7362.60	7360	7367	7366	7350	8161	8162	8136	8137	3321	3320.53	3367.40	3366.03	
	5362	5363						7368							3361	3360			
Perforated 				✓				✓	✓	✓		✓		✓			✓	✓	
Edges	Straights	Obliques	Obliques			Straights	Obliques	Flat	Obliques	Flat	Obliques			Straights	Obliques				
								Obliques											
Minimum temperature	15 °C					- 70 °C					- 18 °C				- 70 °C				
Maximum temperature	340 °C (Ideal high temperatures)					340 °C					230 °C Multi-cooking				340 °C (100°C ideal heat chamber)			340 °C	
Oven	✓					✓					✓				✓				
Dishwasher						Occasional to avoid affecting the surfaces										✓			
To be combined with	Baking paper					Silicone mat, baking paper		Supple moulds, silicone mat, baking paper		Silicone mat, baking paper						Baking paper or silicone mat in case of baking; if cold forming: easier removal.			
Delicate products											✓								
Freezing / Deep freezing / storing															✓ ✓ ✓				
WET DOUGHS																			
• Sponge cake	✓	✓																✓	
• « Tuiles », Langues de chat		✓				✓	✓				✓		✓					✓	
• Choux pastry	✓	✓				✓	✓				✓	✓						✓	
• Macaroon	✓	✓				✓	✓				✓	✓						✓	
DRY DOUGHS																			
• Tarts, tartlets, quiches		✓	✓			✓	✓	✓	✓		✓	✓						✓	
• Pizza		✓		✓				✓	✓	✓	✓	✓	✓	✓				✓	
• Pies, galettes		✓	✓	✓				✓			✓	✓	✓	✓				✓	
• Puff pastry	✓	✓	✓	✓						✓								✓	
• Breads and Viennoiserie pastry	✓	✓			✓	✓	✓	✓			✓	✓						✓	
• Sweet shortcrust pastry	✓	✓	✓							✓	✓	✓						✓	
• Tart bases	✓	✓	✓					✓										✓	
Roasting (e.g. nuts)	✓					✓													

For the use in domestic oven of the baking trays, baking supports and mats choose the size 40 x 30 cm max.

The GN and 60 x 40 cm sizes are suitable for professional ovens.

Find our user guide on page 225 for steel / aluminum / stainless steel baking supports



**Steel baking tray straight edges**



Code	Designation	Lcm	Wcm	Hcm	Th.mm	Kg
5362.40		40	30	2	1,2	1,57
5362.60		60	40	2	1,2	2,58
5320.53	GN 1/1	53	32,5	2	1,2	1,97

This black steel plate tray gives perfect heat transmission. This kind of steel plate is perfect for baking; it will not stain the bottoms of cakes or croissants. The surface of this steel plate is micro-roughened, creating an air mattress between the food to be cooked and the metal. Very resistant to long-lasting temperature changes.

**Steel baking tray oblique edges**



Code	Designation	Lcm	Wcm	Hcm	Th.mm	Kg	PU
5321.53	GN 1/1	53	32,5	1	1,2	1,71	5
5321.65	GN 2/1	65	53	1	1,2	3,28	3
5363.40		40	30	1	1,2	1,12	5
5363.60		60	40	1	1,2	2,24	5

This black steel plate tray gives perfect heat transmission. This kind of steel plate is perfect for baking; it will not stain the bottoms of cakes or croissants. The surface of this steel plate is micro-roughened, creating an air mattress between the food to be cooked and the metal. Very resistant to long-lasting temperature changes.

**Aluminium baking tray - Special hard 1,5mm-thick aluminium**

Code	Designation	Lcm	Wcm	Hcm	Th.mm	Kg
7362.60	Straight edges	60	40	2	1,5	1,14



This aluminium tray is specially designed for transmitting the cold in frozen food cabinets.

**Aluminium baking tray - Special hard 1,5mm-thick aluminium**

Code	Designation	Lcm	Wcm	Hcm	Th.mm	Kg	PU
7360.40	Oblique edges	40	30	1	1,5	0,5	5
7360.53	Oblique edges	53	32,5	1	1,5	0,8	5
7360.60	Oblique edges	60	40	1	1,5	0,95	5





**Perforated flat baking tray - hard 1,5 mm thick aluminium**

Code	Designation	Lcm	Wcm	Th.mm
Concept AIR SYSTEM				
7368.30	special for mini domestic oven	30	20	1,5
7368.40		40	30	1,5
7368.53		53	32,5	1,5
7368.60		60	40	1,5



No edge for optimized space : it enables to put a baking paper or a mat completely flat. The perforations ø 3 mm enable an homogeneous cooking.

**Perforated baking tray - Special hard 1,5mm-thick aluminium**

Code	Designation	Lcm	Wcm	Hcm	Th.mm	Kg	PU
Concept AIR SYSTEM							
7367.40	Perforated ø 3 mm, oblique edges	40	30	1	1,5	0,5	5
7367.53	Perforated ø 3 mm, oblique edges	53	32,5	1	1,5	0,6	5
7367.60	Perforated ø 3 mm, oblique edges	60	40	1	1,5	0,72	5



The perforated plate with formed edges is ideal for use in fan ovens. Example : toasting almonds. It is a perfect support for cooking in silicone pastry moulds.

**Non-stick aluminium perforated rectangular pastry tray - Holes ø 3 mm**

Code	Designation	Lcm	Wcm	Th.mm
Concept AIR SYSTEM				
8162.40		40	30	2
8162.53		53	32,5	2
8162.60		60	40	2



This non-stick tray with its slightly raised edges is perfect for making pizzas, flammenkuche, etc. The bottom is perforated to enable you to obtain a crusty-baked pie bottom. Easy to clean.

**Non-stick baking tray aluminium, oblique edges, thickness 1,5 mm**

Code	Designation	Lcm	Wcm	Hcm	Th.mm	Kg	PU
8161.40	Rectangular pastry tray	40	30	1	2	0,65	5
8161.60	Rectangular pastry tray	60	40	1	2	1,3	5
8161.35	GN 2/3	35	32		2	0,62	5
8161.65	GN 2/1	65	53	1	2	1,9	5
8161.53	GN 1/1	53	32,5	1	2	0,95	5



These aluminium non-stick baking trays are designed for oven-cooking and are coated with "Choc" PTFE, ensuring optimum non-stick qualities. The edges are flared, thus preventing preparations from running off the plate during cooking.

**Stainless steel baking tray, oblique edges, Th. 1mm**

Code	Designation	Lcm	Wcm	Hcm	Th.mm	Kg	PU
3321.53	GN 1/1	53	32,5	1	1	1,34	5
3321.65	GN 2/1	65	53	1	1	2,72	5
3361.40		40	30	1	1	0,9	5
3361.60		60	40	1	1	1,84	5



Made from stainless steel, this tray is perfectly hygienic and easy to keep clean.





**Perforated stainless steel baking tray**

Code	Designation	Lcm	Wcm	Hcm	Th.mm
Concept AIR SYSTEM					
<b>3367.40</b>		40	30	1	1



Durable stainless steel - suitable for intensive professional use.  
For hot or cold use  
Faster and homogeneous cooking thanks to the 3-mm perforations for a crispy result.  
Robust & undistortable - 1 mm thick. Oblique edges.

Oven cooking : the best ally of your silicone mats with its micro-perforation for a perfectly homogeneous air circulation. Associate

the tray with baking sheets, supple pastry moulds or perforated stainless steel moulds,...

Cold use : resistant to low temperatures and humidity. Perfect support to block preparations and desserts in the freezer or deep freezer.

Easy care of the stainless steel. Dishwasher safe.

**Perforated stainless steel baking tray - for 3 baguettes**

Code	Designation	Lcm	Wcm	Th.mm
Concept AIR SYSTEM				
<b>3366.03</b>		40	24,5	1



Stainless steel perforated tray.  
Durable, suitable for intensive professional use. Robust & undistortable.  
For hot or cold use.  
Concept AIR SYSTEM: micro-perforation for a perfect air circulation.  
To combine with baking sheet/paper or de Buyer Airmat silicone baking mat.



**Stainless steel baking tray, straight edges, Th. 1mm**

Code	Designation	Lcm	Wcm	Hcm	Th.mm	Kg
<b>3320.53</b>	GN 1/1	53	32,5	1,5	1	1,55
<b>3360.60</b>		60	40	1,7	1	2,13



Made of stainless steel, this straight-edged tray is perfectly hygienic and easy to keep clean.

**Round-edge tray, stainless steel**



Code	Designation	Lcm	Wcm	Th.mm	Kg	PU
<b>3201.24</b>		24	19	0,8	0,31	5
<b>3201.31</b>		31	24	0,8	0,5	5

This tea tray guarantees your preparations a particularly elegant appearance. It is easy to keep clean. The corners are rounded.

Baking wire grate, st. steel

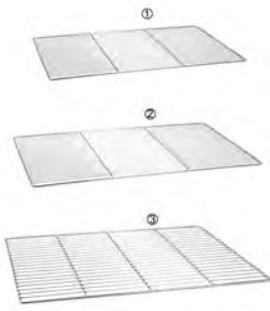

Code	Designation	Lcm	Wcm	Th.mm	Kg	PU
3330.53N	GN 1/1 - 2 crosspieces (1)	53	32,5	2	0,57	5
3330.60N	St. steel grate 60x40 cm 2 crosspieces (2)	60	40	2	0,79	5
3330.65N	GN 2/1 - 3 crosspieces (3)	65	53	3	1,7	5

This professional stainless steel cake grate is easy to keep clean. The crossbars and frame are 5mm (3/16") diameter and the grid wire 2mm (1/16"). It is very robust and will not distort.

Baking non-stick silicone mat



Code	Designation	Lcm	Wcm	Kg
4931.40N		40	30	0,1
4931.58N	for tray 60 x 40 cm	58,5	38,5	0,21
4931.51N	for tray GN 1/1	51,5	31	0,14

This cooking mat is made from canvas dipped in food-grade silicone to prevent any sticking whatsoever. It replaces greaseproof paper and can stand an average 1000 visits to the oven.

Maximum temperature: 280°C (536°F). This mat can also be used as an underlying support for freezing and deep-freezing. It is easily cleaned with hot water and a sponge.



Silicone coated fiberglass baking mesh "AIRMAT"



AIR SYSTEM  
de Buyer Concept

Code	Designation	Lcm	Wcm	Kg
4938.40		40	30	0,06
4938.58	For tray 60 x 40 cm	58,5	38,5	0,11
4938.51	For tray GN 1/1 Concept AIR SYSTEM	51,5	31	0,09

Perfect for baking choux paste and bread & tart doughs. Ideal to bake rawfrozen doughs. Can be used as a freezing support. Use T°: -55°C à +280°C (-67°F to +536°F). Ventilated fabric for an homogeneous cooking and crispy dough bottoms.

Silicone-coated nonstick fiberglass fabric: do not grease. Foodgrade Platinum Liquid Silicone. The baking mat is to combine with a perforated aluminium oven tray.



Non-stick silicone pastry mat with marks for Macarons cooking



Code	Designation	Lcm	Wcm	Th.mm	Kg
	Circles ø 15 and 35 mm -40°C / + 230°C (-40°F / +446°F)				
4935.40	44 round marks	40	30	0,8	0,16
4935.60	88 round marks	60	40	0,8	0,21

Drawings ø 35 mm are really useful for covering the tray keeping lines for filling with a pastry bag for Macarons. The small circles ø 15 mm help to place the pastry bag in the centre and realize perfect macarons. This product will be useful for mass production in order to obtain always the same finishing touches. Non-stick, suitable for oven cooking. To combine with the flat tray 7368.



Non-stick silicone pastry mat with marks



Code	Designation	Lcm	Wcm	Kg
	Non-stick recto / non-skid verso Marks for tarts ø 12 - 16 - 20 - 24 - 28 - 32 cm Graduated in cm and inches			
4937.60		60	40	0,36

This silicone pastry mat allows pie pastry to be rolled on a worktop without the need to dust it with flour. The marks indicate the upright quantity of pastry to the exact size of the tart mould. Graduated on the sides. This mat can also be used in the oven as a baking mat or as an underlying support for freezing and deep-freezing (-60°C/+260°C). Easy cleaning.



Baking non-stick sheet



Code	Designation	Øcm	Lcm	Wcm	Kg	PU
from - 170°C to + 260 °C						
PROFESSIONAL SIZE :						
<b>4344.08N</b>	60 x 40 cm - 0,08 mm thick		60	40	0,03	10
<b>4344.13N</b>	60 x 40 cm - 0,13 mm thick		60	40	0,05	10
SMALL SIZE :						
Delivered in decorated box						
<b>4344.01</b>	40 x 30 cm		40	30	0,01	1
<b>4344.02</b>	Round ø 26 cm	26			0,01	1

This baking sheet is made from PTFE-coated glass fiber for perfect non-stick properties. It has the advantage of being reusable 200 times over. It proves to be very economical and can be used for lots of different applications.

Silicone-coated baking paper - 100 % natural



Code	Designation	Lcm	Wcm	Hcm	Kg
PROFESSIONAL SIZE :					
<b>4359.00</b>	Box of 250 sheets 60 x 40 cm	60	40	2	2,74
<b>4358.00</b>	Box of 250 sheets GN 1/1	53	32,5	2	1,92
SMALL SIZE :					
<b>4357.00</b>	Roll l. 38 cm x 8 m				0,13
Delivered in decorated box					

Baking paper unbleached - Brown  
 - Non-stick Silicone coated  
 - double side  
 - Reusable  
 Natural & Ecological. For oven cooking (traditional and microwave) of pastry, breads and special frozen products until 220°C (428°F).  
 100% natural fibre 100% PEFC \* & PFOA free guaranteed



**Box of 9 cutters made of polyamid**



Code	Designation	Kg
4308.00	Plain round ø 2 to 10 cm	0,23
4307.00	Fluted round ø 2 to 10 cm	0,22
4304.30	Square - L.1,8 to 9,5 cm	0,27

Polyamid reinforced with glass fibre. Extra-strong quality. Solid and resistant. One-piece construction for perfect hygiene. Can be sterilized - T° max. 160°C

35 mm high - Round edge for comfortable handling

**Box of 9 round cutters - stainless steel**



Code	Designation	Hcm	Th.mm	Kg
3323.00N	Plain ø 3 to 11 cm	3,5	0,6	0,44
3324.00N	Fluted ø 3 to 11 cm	3,5	0,6	0,46

These professional-grade stainless steel star pastry cutting rings are very sturdy and will not distort. They will satisfy every need thanks to the different forms available. It is the tool which will satisfy your creativity thanks to the 2 different aspects suggested.

**Rolling pins**



Code	Designation	Øcm	Lcm	Kg
4840.01N	Beech rolling pin	5	50	0,72



**Wheels for pastry in food plastic material**



Code	Designation	Øcm	Lcm	Kg
	Cutting wheel for grating pastry			
4361.00N		4,5	5	0,07
4361.01N		4,5	10	0,14
	Spiked roller			
4362.00N		6,5	5	0,07
4362.01N		6,5	10	0,14

The criss-cross slitter lets you make diamond holes in the pastry for decorating pie-tops. Once the pastry has been through the roller, you just need to stretch it to obtain perfect diamond holes. The pastry-spiking roll is handy for pricking holes quickly and uniformly in strips of pastry.



**Set of 10 disposable baker blades**



Code	Designation	Lcm	Kg
4670.03N	Yellow-fixed blades	13	0,01
4670.05N	Blue-reversible blades	14	0,01

Baker's blades let you slit the dough before baking bread. The blade's cutting edge guarantees you a high quality cut.

Scraper



Code	Designation	Lcm	Wcm	Hcm	Th.mm	Kg	PU
3300.12	Straight dough scraper, stiff, st. steel	12	9	2,5	1	0,18	1
3301.12	Round dough scraper, stiff, st. steel	12	9	2,5	1	0,14	1
3302.11N	Dough straight scraper, supple steel	11	8,8	2,5	0,3	0,09	12
3302.12N	Dough round scraper, supple steel	11	8,8	2,5	0,3	0,08	12

The rigid or flexible pastry cutters are used for cutting out and cleaning pastry, bread dough, or pizza pastry, and also for scraping

Supple plastic scraper



Code	Designation	Lcm	Wcm	Th.mm	Kg	PU
4858.00N	Supple round scraper T° max. 60 °C	15	11	2	0,02	5

This utensil lets you scrape out a bowl to remove any mixture stuck to the walls.

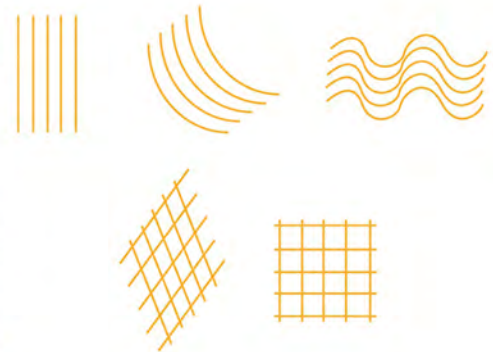

Expanding pastry cutter - Stainless steel



This expanding roller carries several stub spindles, each with a cutting wheel, and allows you to cut a series of straight strips in one go. The width is adjustable.

Code	Designation	Lcm	Wcm	Hcm	Kg
4781.00N	5 plain wheels ø 5,5 cm to cut 4 strips From 1 to 11,5 cm large	22,5	5,2	5,5	0,56
4781.01	Double 5 plain wheels and 5 fluted wheels ø 5,5 cm to cut 4 strips From 1 to 11,5 cm large	27	7,8	5,5	0,97



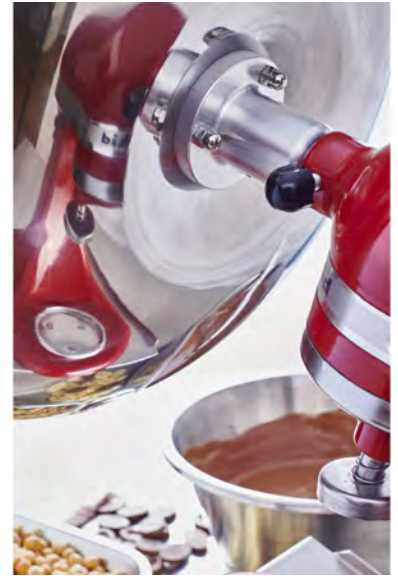

**Stainless steel sweet maker - Coating system**



Code	Designation	Øcm	Kg
3500.00	Sweet maker	40	4,2
	Created by Pascal Brunstein Ruban Bleu 1997		
	SPARE PARTS :		
3500.01	mandrel for sweet maker		



The sugar coater enables dried fruits (almonds, hazelnuts, walnuts, etc.) to be sugar coated or to be covered with chocolate, marzipan... 6 to 8kg (13-18lbs) of sweets or candies can be made in 30 minutes.  
Improved fastening system.  
The stainless steel double bell fits onto beaters :  
- KITCHENAID K5 Super Plus

- KITCHENAID ARTISAN PRO  
- Dito Sama BE5 A  
- Dito Sama 3500.00  
Beater is not supplied.



**Bain-marie cooker**



The double boiler cooker consists of a hollow stainless steel shell in which water is heated. It enables to heat at lukewarm temperatures. No burning, no sticking, no boiling over.

Examples of uses :

- Melting chocolate.
- Preparing sauces or creams.
- Maintaining temperature of preparations.
- Reheating dishes.
- Heating milk etc.

Suitable on all heat sources incl. induction hobs.

Code	Designation	Øcm	Hcm	Liters.	Th.mm	Kg
3437.16N	With handle and double st. steel body	16	12,5	1,5	1	0,97



**Set of 5 polyethylene sheets for chocolate work**



Code	Designation	Lcm	Wcm	Kg
042032		30	20	0,02

Delivered in decorated box

Cold use.



**4 supple plastic sheets in relief for cream cake decoration**



Code	Designation	Kg
4343.00	For yule log 3206.30 30 x 18,5 cm Delivered in decorated box	0,1

The supple plastic sheet is to place in the mould for rolled-cake or in the pastry frame before making your cream cake.  
An original relief decoration on the cake is obtained after freezing.  
4 patterns are available.  
No oven cooking. No dishwasher  
MADE IN FRANCE

**Sugar saucepan, massive copper, 2 spouts and st. steel cold handle**



Code	Designation	Øcm	Hcm	Liters.	Th.mm	Kg
6572.20		20	11	3,4	2	1,8

This sugar saucepan with two pouring lips (for left- or right-handed people) has a stainless steel handle that remains cold so as not to burn the user's hand.

**Candy thermometer +80°C / +200°C with stainless steel case**



Code	Designation	Øcm	Lcm	Kg
4884.01N	PRECISION 1/1	0,2	27,5	0,1

This thermometer is used for pastry and candy. It is calibrated to allow for immersion of the lower thinner part of the stem. The

protective sleeve can be sterilized at 100°C. The thermometer and sleeve can be washed in a dishwasher.

**Copper massive conical jam pans with cast-iron handles**

Code	Designation	Øcm	Hcm	Liters.	Th.mm	Kg
6200.38N	Conical jam pan, 1 mm th	38	15	9	1,2	1,5
6202.40N	Conical jam pan, 2 mm th	40	14,4	12	1,7	3,4



**Stainless steel funnel for jam and to pour preparations in ring**



Code	Designation	Kg
3356.00	2 parts for ø from 3,5 to 6 cm	0,23

This funnel is also practical to pour preparations in ring for arranging filling on a dish.



**Pastry nozzles made of TRITAN.**

Transparent black colour.  
 Solid - One-piece construction.  
 Perfectly smooth cone for guaranteed hygiene.  
 The reinforced teeth on the fancy nozzles make high accuracy work.  
 The nozzles are long enough, making them easier to insert in the bag and giving them better visibility.  
 They all fit with LE TUBE de Buyer and are dishwasher friendly.  
**MADE IN FRANCE**

Available leaflet ref.QEC21.010



**Plain nozzle - Tritan**



Code	Designation	Øcm	Hcm	Kg
4151.03	Ø 3 mm - U2	3,5	6	0,01
4151.06	Ø 6 mm - U4	3,5	6	0,01
4151.08	Ø 8 mm - U6	3,5	6	0,01
4151.11	Ø 11 mm - U8	3,5	6	0,01
4151.13	Ø 13 mm - U10	3,5	6	0,01
4151.15	Ø 15 mm - U12	3,5	6	0,01
4151.18	Ø 18 mm - U14	3,5	6	0,01

**Saint Honoré nozzle - Tritan**

Code	Designation	Øcm	Hcm	Kg
4155.09	Ø 9 mm	3,5	6	0,01
4155.11	Ø 11 mm	3,5	6	0,01



The spout has a cut-out. They are used for dressing Saint-Honorés with cream. They do a much better job than a spoon.



**'Petit Four' star nozzles - Tritan**

Code	Designation	Hcm	Kg
4156.10	PF10 Ø 10 mm - 14 teeth	6	0,01
4156.14	PF14 Ø 14 mm - 16 teeth	6	0,01
4156.18	PF18 Ø 18 mm - 18 teeth	6	0,01





**Tritan Star nozzle**



Code	Designation	Øcm	Hcm	Kg
4152.05	A8 - ø 3 mm	3,5	6	0,01
4152.09	B8 - ø 5 mm	3,5	6	0,01
4152.11	C6 - ø 8 mm	3,5	6	0,01
4152.13	C8 - ø 8 mm	3,5	6	0,01
4152.17	D8 - ø 11 mm	3,5	6	0,01
4152.19	E6 - ø 13 mm	3,5	6	0,01
4152.20	E8 - ø 13 mm	3,5	6	0,01
4152.25	F8 - ø 18 mm	3,5	6	0,01

**Star ribbon nozzle - Tritan**



Code	Designation	Øcm	Hcm	Kg
4153.08	8 points hole 19 x 2 mm	3,5	6	0,01

One flat side and one indented side for decorating Yule logs.



**Bird nest nozzle - Tritan**



Code	Designation	Øcm	Hcm	Kg
4166.01	19 holes ø3 mm	3,5	4,5	0,01



**Leaf nozzle - Tritan**



Code	Designation	Øcm	Hcm	Kg
4168.02	F2	3,5	6	0,01



Garnishing nozzles - Tritan

Code	Designation	Øcm	Hcm	Kg
4165.06	Nozzle ø 6 mm	3,5	9	0,01
4165.10	Nozzle ø 10 mm	3,5	9	0,01



GEO nozzle - Tritan



Code	Designation	Øcm	Hcm	Kg
4183.05	Square 5 mm	3,5	6	0,01
4183.10	Square 10 mm	3,5	6	0,01
4181.10	Triangular 10 mm	3,5	6	0,01
4182.12	Rectangular 12 x 6 mm	3,5	6	0,01
4180.14	Half ø 14 mm	3,5	6	0,01

EXCLUSIVITY DE BUYER





Box of 6 plain Tritan nozzles and supple holder

Box of 6 plain Tritan nozzles and supple holder



Code	Designation	Lcm	Wcm	Hcm	Kg
4150.10	6 plain nozzles - U2-4-6-8-10-12	16,5	8,5	7	0,05

Code	Designation	Lcm	Wcm	Hcm	Kg
4150.11	6 star nozzles B8-C6-C8-D8-E6-E8	16,5	8,5	7	0,05

Box supplied with an holder made in TPE for 6 nozzles Tritan. Equipped with a hole to hang. Nozzles are easy to clip, unclip, clean, dry and store. No nozzle gets lost.

Box of 6 Tritan nozzles and supple holder



Code	Designation	Lcm	Wcm	Hcm	Kg
4150.02	Set CLASSIC - 3 plain nozzles ø 6-11-13 mm - 3 Star nozzles B8-C6-E8	16,5	8,5	7	0,05
4150.03	Set CREATIVE - 2 Star nozzles PF10 - PF14 / 1 leaf nozzle - 1 ribbon nozzle / 1 bird nest / 1 St Honoré ø 9 mm	16,5	8,5	7	0,05
4150.05	Set GEO - 1 plain nozzle ø 8 mm - 5 GEO : 2 squares / triangle / rectangle / hemisphere	16,5	8,5	7	0,05
4150.07	Set STARTER - 3 plain nozzles ø 3-8-15 mm - 3 Star nozzles A8-C8-F8	16,5	8,5	7	0,05
4150.08	FILLING set - 1 plain nozzle ø 11 mm / 2 Star nozzles PF10 - PF14 - 2 filling nozzles ø 6-10 mm / 1 GEO rectangular nozzle	16,5	8,5	7	0,05

Box supplied with an holder made in TPE for 6 nozzles Tritan. Equipped with a hole to hang. Nozzles are easy to clip, unclip, clean, dry and store. No nozzle gets lost.

REF 4150.09



Box of 12 Tritan nozzles and 2 supple holders



Code	Designation	Lcm	Wcm	Hcm	Kg
<b>4150.04</b>	SET MIX (4150.02+4150.03) CLASSIC + CREATIF - 3 plain nozzles ø 6-11-13 mm - 3 Star nozzles B8-C6-E8 - 2 Star nozzles PF10 - PF14 / 1 leaf nozzle - 1 ribbon nozzle / 1 bird nest / 1 St Honoré ø 9 mm	21	12,5	7	0,1
<b>4150.09</b>	CATERER SET with : - 4 plain nozzles U4-6-8-12 - 4 star nozzles n° C6 - C8 - D8 - E6 - 1 leaf nozzle - 1 star ribbon nozzle 8 teeth - 2 St Honoré ø 9 - 11 mm	21	12,5	7	0,1

All de Buyer Tritan nozzles suits on LE TUBE ref. 3358.--

Special shortbread biscuits kit for LE TUBE



Code	Designation	Kg
<b>3358.94</b>	Special lid disc holder + 13 discs + 2 caps ref.3358.92 to store the paste	0,17

Kit composed with a special lid (disc holder) and 13 removable decor discs.  
Delivered with 2 caps ref. 3358.92  
Fits on LE TUBE.



LE TUBE the essential box

new  
2023



Code	Designation	Kg
3358.00	LE TUBE delivered with 2 nozzles U8 (ø11 mm) & D8	0,44

Pressure syringe for effortless dosing of paste, creams and mousses. DESIGNED BY DE BUYER - PATENTED  
 For garnishing, filling and decorating. Simple, fast and accurate work. Easier to fill than a pastry bag, 0,75 L. capacity in transparent plastic.  
 Graduated in cl and oz. Allows the user to see how much is left.  
 Knob for easy setting of pressure for dosing the amount to be poured (from 1 to 5 cl).  
 Removable and interchangeable nozzles.

LE TUBE: Pressure pastry syringe



Code	Designation	Lcm	Wcm	Hcm	Liters.	Kg
3358.01	Delivered with 2 nozzles U8 (ø11 mm) & D8 + 2 caps + biscuits kit REF 3358.94	38,4	10,5		0,75	0,68
3358.92	Set of 2 lids for the tank					0,05
3358.93	Set of 2 lids with hole for the tank					0,05
3358.75	0,75 capacity extra tank + 2 caps ref.3358.92	19,6	8,54		0,75	0,13
3358.95	DISPLAY WITH VIDEO : - 8 boxes Le Tube 3358.01 - 9 sets of 6 Tritan nozzles (3 X 4150.02 / 3 X 4150.03 / 3 X 4150.08) - 5 tanks 3358.75	50	39	150		15,62

Pressure syringe for effortless dosing of paste, creams and mousses. Graduated in cl and oz. Allows the user to see how much is left.  
 For garnishing, filling and decorating. Simple, fast and accurate work. Easier to fill than a pastry bag, 0,75 L. capacity in transparent plastic. Knob for easy setting of pressure for dosing the amount to be poured (from 1 to 5 cl).  
Removable and interchangeable nozzles.

Box LE TUBE PRO



Code	Designation	Lcm	Wcm	Hcm	Kg
3358.02	This box includes: - Piston syringe LE TUBE - 4 extra containers 0.75 L. - 12 nozzles with holders: 3 plain nozzles ø 6-11-13 mm 3 star nozzles B8-C8-E8 / 2 star nozzles PF10 - PF14 1 St Honoré / 1 bird nest nozzle 1 garnishing nozzle ø 6 mm 1 garnishing nozzle ø 10 mm	47	30	10	1,82



U2 - ø3mm



U3 - ø4mm



U4 - ø6mm



U5 - ø7mm



U6 - ø8mm



U7 - ø10mm



U8 - ø11mm



U10 - ø13mm



U11 - ø14mm



U12 - ø15mm



U14 - ø18mm



U15 - ø20mm



**Stainless steel plain nozzle**



Code	Designation	Øcm	Hcm	Kg
2111.02N		0,2	5	0,01
2111.03N		0,3	5	0,01
2111.04N		0,4	5	0,01
2111.05N		0,5	5	0,01
2111.06N		0,6	5	0,01
2111.07N		0,7	4,5	0,01
2111.08N		0,8	4,5	0,01
2111.09N		0,9	4,5	0,01
2111.10N		1	5,4	0,01
2111.11N		1,1	5	0,01
2111.12N		1,2	5	0,01
2111.13N		1,3	5	0,01
2111.14N		1,4	5	0,01
2111.15N		1,5	5,4	0,01
2111.16N		1,6	5,3	0,01
2111.17N		1,7	5,3	0,01
2111.18N		1,8	5	0,01
2111.20N		2	5	0,01
2111.22N		2,2	4,9	0,01
2111.24N		2,4	4,5	0,01

These stainless steel nozzles without welding are robust, easy to clean and hygienic. They fit onto piping bags for making patterns with cream or for filling the hollows in a baking preparation.

**Stainless steel star nozzle**



Code	Designation	Øcm	Kg
2112.02N	A5	0,3	0,01
2112.03N	A6	0,3	0,01
2112.04N	A7	0,35	0,01
2112.05N	A8	0,5	0,01
2112.06N	B5	0,5	0,01
2112.07N	B6	0,5	0,01
2112.08N	B7	0,6	0,01
2112.09N	B8	0,7	0,01
2112.10N	C5	0,7	0,01
2112.11N	C6	0,7	0,01
2112.12N	C7	0,7	0,01
2112.13N	C8	0,9	0,01

These stainless steel nozzles without welding are robust, easy to clean and hygienic. They fit onto piping bags for making cream patterns or for filling the hollows in a baking mixture.

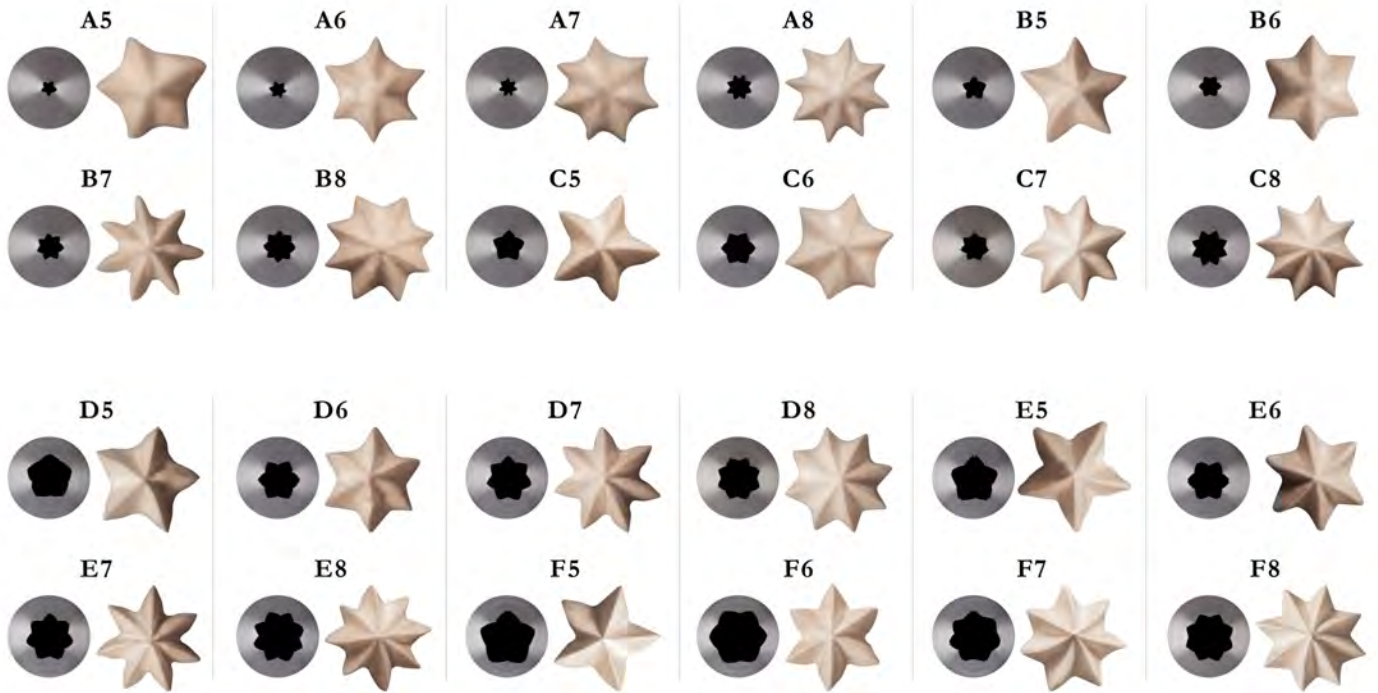

**Stainless steel star nozzle**



Code	Designation	Øcm	Kg
2112.14N	D5	1,1	0,01
2112.15N	D6	1,1	0,01
2112.16N	D7	1,1	0,01
2112.17N	D8	1,1	0,01
2112.18N	E5	1,3	0,01
2112.19N	E6	1,3	0,01
2112.20N	E7	1,3	0,01
2112.21N	E8	1,3	0,01
2112.22N	F5	1,8	0,01
2112.23N	F6	1,8	0,01
2112.24N	F7	1,8	0,01
2112.25N	F8	1,8	0,01

These stainless steel nozzles without welding are robust, easy to clean and hygienic. They fit onto piping bags for making cream patterns or for filling the hollows in a baking mixture.

**Stainless steel ruban nozzle**



Code	Designation	Øcm	Hcm	Kg
2117.10	10 x 2 mm	2,5	4,5	0,01
2117.15	15 x 2 mm	3,2	4,5	0,01
2117.20	20 x 2 mm	3,2	4,5	0,01
2117.30	30 x 5 mm	3,6	4,5	0,01



**Stainless steel star ribbon nozzle**



Code	Designation	Øcm	Hcm	Kg
2113.06N	6 points- hole 16 x 2 mm	2,5	4	0,01
2113.08N	6 points - hole 20 x 3 mm	3	4,5	0,01

These stainless steel nozzles without welding are robust, easy to clean and hygienic. They have one flat side and one indented side and are used for decorating Yule logs.

**Stainless steel Sultane nozzle - Small size Ht 4,5 cm**



Code	Designation	Hcm	Kg
2118.31	Plain	4,5	0,01
2118.12	Star	4,5	0,01

**Stainless steel Sultane nozzle**



Code	Designation	Hcm	Kg
2118.01	Protruding cone	6,3	0,03
2118.02	Flat cone-up	6,3	0,03

UP : outer ø35 mm  
cone inside ø21 mm  
ø base 55 mm



**Stainless steel Sultane mini nozzle**



Code	Designation	Øcm	Hcm	Kg
2118.03	ø 7 mm - 12 teeth	1,8	2,85	0,01

**Stainless steel Saint Honoré nozzle**



Code	Designation	Øcm	Hcm	Kg
2115.20N		0,9	5	0,01
2115.25N		1,1	5	0,01
2115.30N		1,3	5	0,01
2115.35N		1,5	5	0,01
2115.40N		1,6	5	0,01

These stainless steel nozzles are robust, easy to clean and hygienic thanks to their watertight "end-to-end" welding. The spout has a cut-out. They are used for dressing Saint-Honorés with cream. They do a much better job than a spoon.



**Leaf nozzle, stainless steel**



Code	Designation	Hcm	Kg
2128.02N	N° 2 - large 6 mm	6	0,01

These stainless steel nozzles without welding are robust, easy to clean and hygienic.



**Rose nozzle, stainless steel - 8 points**



Code	Designation	Øcm	Hcm	Kg
2129.08N		0,8	5	0,01
2129.09N		0,9	5	0,01
2129.11N		1,1	5	0,01
2129.14N		1,4	5	0,01
2129.16N		1,6	5	0,01

These stainless steel nozzles without welding are robust, easy to clean and hygienic.

**Bird nest nozzle, stainless steel**



Code	Designation	Øcm	Hcm	Kg
2126.00N	7 holes ø 1.3 mm	1,3	3,95	0,01
2126.01	9 holes ø 3 mm	1,9	3,95	0,01

These stainless steel nozzles without welding are robust, easy to clean and hygienic.



**Bird nest nozzle, stainless steel - 3 fluted holes**



Code	Designation	Øcm
2126.02		3,1

These stainless steel nozzles without welding are robust, easy to clean and hygienic.

**Stainless steel nozzle - spiral effect**



Code	Designation	Øcm	Hcm
2119.13	8 teeth	1,3	4,15

These stainless steel nozzles without welding are robust, easy to clean and hygienic.

**Stainless steel 'Petit Four' star nozzles**

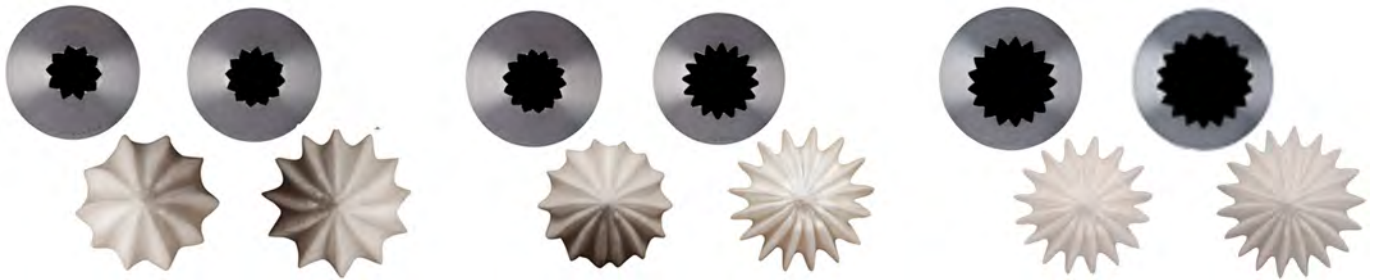

Code	Designation	Hcm	Kg
2116.07	ø 7 mm - 10 teeth	4,8	0,05
2116.08	ø 8 mm - 12 teeth	4,3	0,07
2116.10	ø 10 mm - 14 teeth	5	0,01
2116.14	ø 14 mm - 16 teeth	5,5	0,01
2116.16	ø 16 mm - 17 teeth	5,3	0,08
2116.17	ø 17,5 mm - 18 teeth	4,8	0,05

**Sphere nozzle, stainless steel**



Code	Designation	Øcm	Kg
2120.20	with fine streaks	2,5	0,01
2120.21	with large streaks	2,5	0,01

These stainless steel nozzles without welding are robust, easy to clean and hygienic.



**Russian nozzle, stainless steel - Flower decor N°241 - N°242**



Code	Designation	Øcm	Hcm
2120.01	N°241	2,67	3,85
2120.02	N°242	2,67	3,85

These stainless steel nozzles without welding are robust, easy to clean and hygienic.

**Russian nozzle, stainless steel - Flower decor N°243 - N°244**



Code	Designation	Øcm	Hcm
2120.03	N°243	2,67	3,85
2120.04	N°244	2,67	3,85

These stainless steel nozzles without welding are robust, easy to clean and hygienic.

Russian nozzle, stainless steel - Flower decor - N°246 - N°247

Russian nozzle, stainless steel - Flower decor N°257 - N°248



Code	Designation	Øcm	Hcm
2120.05	N°246	2,67	3,85
2120.06	N°247	2,67	3,85

Code	Designation	Øcm	Hcm
2120.08	N°248	2,67	3,85
2120.07	N°257	2,67	3,85

These stainless steel nozzles without welding are robust, easy to clean and hygienic.

These stainless steel nozzles without welding are robust, easy to clean and hygienic.

Garnishing nozzles



Code	Designation	Hcm	Kg
2125.06	Nozzle ø 6 mm	8,2	0
2125.03	Set of 3 nozzles ø 4-6-8 mm		0,01

Set of 5 stainless steel nozzles



Code	Designation	Kg
2114.05	in blister package - 2 plain nozzles ø 8 and 2 mm - 1 star ribbon nozzle 8 teeth 1 garnishing nozzle ø 6 mm - Star nozzle C6	0,06

Set of 6 stainless steel nozzles



Code	Designation	Kg
2114.00N	Set of 6 st. steel nozzles	0,04



Counter display of stainless steel nozzles and accessories



Code	Designation	Lcm	Wcm	Hcm	Kg
2130.03	Display with video screen and booklets	52,5	30	48	4,1
	50 models of stainless steel nozzles - total 241 nozzles- and accessories (adapters, scraper and pastry bags)				
	Consult us for the detailed composition.				
	Video screen runs off battery and can be recharged.				

Stainless steel pastry nozzles. Perfectly smooth. Easy cleaning. Dishwasher safe. Suitable for all piping bags.

MAXI PASTRY BOX: set of 120 stainless steel nozzles



Code	Designation	Lcm	Wcm	Hcm	Kg
2130.01	24 different nozzles in 5 ex	28	18,5	8	1,22
	- 7 Plain ø 6/8/10/12/14/16/18 mm				
	- 6 Star A8/C6/D6/D8/E8/F8				
	- 2 Star ribbon 6 teeth L.16 mm - L.20 mm				
	- 2 St Honoré ø 11 mm - ø 15 mm				
	- 2 Petits Fours ø 8 mm - ø 14 mm				
	- Garnishing nozzle ø 6 mm				
	- Bird nest nozzle				
	- Leaf nozzle N°2				
	- 2 Rose nozzles ø 8 mm - ø 11 mm				

Stainless steel pastry nozzles. Perfectly smooth. Easy cleaning. Dishwasher safe. Suitable for all piping bags.

Adapter for nozzles made of foodgrade plastic



Code	Designation	Hcm	Kg
2114.11	Kit for large nozzles ø 35mm	5,8	0,02
2114.12	Kit for medium nozzles ø 25mm	5,7	0,03
2114.21	Kit for decor nozzles ø 20mm While stocks last	3	0,02
2114.13	Set of 3 adapters for the 3 sizes of nozzles ø 35/25/20 mm		0,1

Adapters enable to change of nozzles on the same pastry bag.

Set of 35 stainless steel pastry nozzles + 2 adaptators



Code	Designation	Lcm	Wcm	Hcm	Kg
2114.10		30	24	6,3	0,87

Case with a traditional pastry assortment of 35 nozzles:  
 - 10 plain nozzles  
 - 15 star nozzles  
 - 5 nozzles for Petit Four  
 - 2 nozzles for Rose  
 - 2 ribbon nozzles  
 - 1 nozzle to garnish .  
 Supplied with adapters to change nozzles on the same pastry bag.

Set of 26 small stainless steel decor nozzles

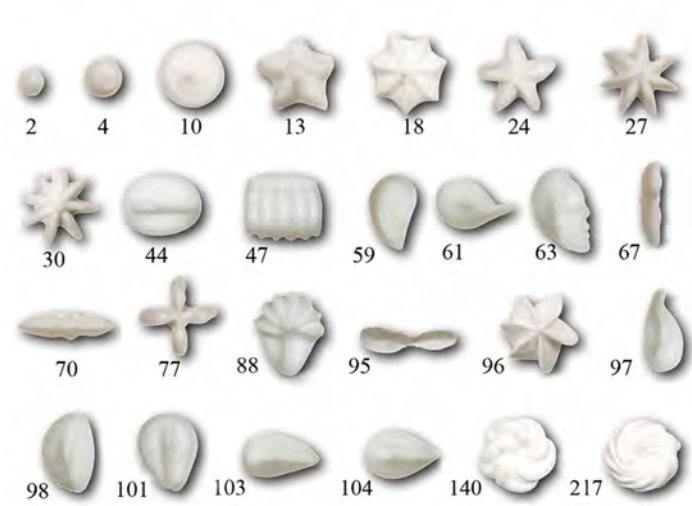

Code	Designation	Lcm	Wcm	Hcm	Kg
2114.20		19,2	14	4,8	0,27

Case with 26 st/steel decor nozzles + an adaptator + 2 supports to make decorations in chocolate/cream/glaze for writing or creating leaves, flowers, ...  
 Supplied with an adapter to change nozzles on the same pastry bag.

Holder for pastry bag, polypropylene



Code	Designation	Øcm	Hcm	Kg
4347.10N		19,5	23	0,12

This pastry bag holder is made of food plastic and enables one to maintain the full pastry bag straight, ready to use.

**Nylon extra supple pastry bags**



Code	Designation	Lcm	Kg
4859.34		34	0,01
4859.46		46	0,01

The professional re-usable pastry bags made of coated cotton are particularly supple. They have a string, but no hem. They are lined and then watertight.



**Cotton pastry bags**



Code	Designation	Lcm	Kg	PU
4856.25N	pastry bag 25 cm	25	0,04	6
4856.30N	pastry bag 30 cm	30	0,04	6
4856.35N	pastry bag 35 cm	35	0,05	6
4856.40N	pastry bag 40 cm	40	0,06	6
4856.45N	pastry bag 45 cm	45	0,07	6
4856.50N	pastry bag 50 cm	50	0,11	6
4856.60N	pastry bag 60 cm	60	0,16	6
4347.05N	Set of 5 cotton pastry bags 30/35/40/45 and 50 cm long		0,13	1

The professional re-usable pastry bags made of coated cotton are particularly strong. They have a string, but no hem. They are lined and then watertight.

**Supple pastry bag made of polyurethane**



Code	Designation	Lcm	Wcm	Kg
4347.35		35	20	0,02

Foodgrade polyurethane. This innovative material gives to the bag high resistance, flexibility and softness. It has a smooth surface inside which make easier the outflow of the product and rough outside for a better handle. Thanks to a special welding of the bag, a high hygienic safety is guaranteed. Easy cleaning. Dishwasher safe. Resists until 60°C maximum.

**Supple pastry bag made of polyurethane + 2 stainless steel nozzles**



Code	Designation	Lcm	Wcm	Hcm	Kg
4347.03	Pastry bag L. 35 cm Plain nozzle 2111.10N ø 10 mm Star nozzle C6	24	4	4	0,06
	Packed in plastic box				

Foodgrade polyurethane. This innovative material gives to the bag high resistance, flexibility and softness. It has a smooth surface inside which make easier the outflow of the product and rough outside for a better handle. Thanks to a special welding of the bag, a high hygienic safety is guaranteed. Easy cleaning. Dishwasher safe. Resists until 60°C maximum.



Roll of 20 disposable pastry bags - Polyethylene

Code	Designation	Øcm	Lcm	Wcm	Kg
4348.02		4	23	4	0,14
Delivered in decorated box					



The throw-away piping bags have the same use as the nylon ones but without the inconvenience of cleaning and upkeep. Reinforced edges. T° 70°C max.

Roll of 100 disposable pastry bags - Blue polyethylene



Roll of 100 disposable pastry bags - Polyethylene



Code	Designation	Lcm	Liters.	Kg
4349.55		55	1,7	1,35

90 microns. Reinforced edges. T° 70°C max.  
Roll in a dispenser box.

Code	Designation	Lcm	Liters.	Kg
4348.30N	30 cm long	30	0,25	0,6
4348.40N	40 cm long	40	0,5	0,95
4348.45N	45 cm long	45	0,75	1
4348.50N	50 cm long	50	1,25	1,2
4348.01N	55 cm long	55	1,7	1,35

The throw-away piping bags have the same use as the nylon ones but without the inconvenience of cleaning and upkeep. Reinforced edges. T° 70°C max.  
Roll in a dispenser box.

Dispenser box of 100 disposable pastry bags - Polyethylene



Code	Designation	Lcm	Wcm	Kg
4346.45N		48	26	1

The throw-away piping bags have the same use as the nylon ones but without the inconvenience of cleaning and upkeep. Reinforced edges. They are made of transparent polypropylene. Their hygiene is perfect. They are also very practical in their dispenser box. 85 microns. T° of use : 80°C during 5 hours.

Set of 8 plastic clips TWIXIT to close pastry bags



Code	Designation	Kg
4336.00	3 different sizes : L. 13 / 10 / 5 cm	0,1



**Silicone brush**



Code	Designation	Lcm	Wcm	Kg
4807.00N		19,5	3	0,02
4807.25N		25	3	0,04
4807.50N		25	6	0,05

Hygienic brush. Easily cleanable. T° resistance until 250°C.

**Large silicone pastry brush**



Code	Designation	Lcm	Wcm	Hcm	Kg
4807.60N	fine silk	25	4	3	0,07

A wider and thicker brush: more preparation (butter, egg yolk...) is taken once and the finest silk allows a more regular brushing without traces. Temperature resistance until 250°C.

**Pastry brushes with wooden handle - Natural bristles**



Code	Designation	Lcm	Wcm	Kg
4805.01N	Set of 2 pastry brushes l.30 mm	23	3	0,4
4805.02N	Set of 2 pastry brushes l.40 mm	24	4	0,6

The pastry brush is used for glazing yeast dough or for coating desserts. It can also be used to moisten the walls of a sugar saucepan.

**Stainless steel horn core**



Code	Designation	Øcm	Lcm	Th.mm	Kg
3006.25		2,5	9	0,3	0,01
3006.30		3	12	0,3	0,01
3006.35		3,5	14	0,3	0,02

This conical mould lets you make puff-pastry horns of plenty.

**Stainless steel tube**



Code	Designation	Øcm	Lcm	Kg	PU
3000.04	Champagne Cork/Mushroom, individual	4	4	0,06	5
3005.02	Cheese Roulé, individual	2,1	10	0,05	5

These stainless steel tubes are especially robust (1.5mm / 16 gauge thick) and easy to keep clean. They help you make catering products (cheese rolls, mini-soufflés, etc.).

**Stainless steel pastry-roll core**



Code	Designation	Øcm	Lcm	Th.mm	Kg
3007.25		2,5	10	0,3	0,01

This tool lets you make puff pastry rolls which can then be filled with sweet or savory mixtures.

**Kitchen blowtorch**



Code	Designation	Hcm	Kg
2040.00N	Delivered empty	15,7	0,17

An absolute must for caramelizing Catalan creams, flans, meringue tarts, or apple tarts, melting cheese, browning meats, peeling tomatoes, and even for paint stripping! Easy and safe to use with its automatic

piezoelectric ignition button and adjustable flame. For use with Butane gas (lighter gas). Easy-to-fill tank.



**Punch bottle**



Code	Designation	Øcm	Hcm	Liters.	Kg
044085N	Punch bottle with plug	8	29	1	0,11

Made from food-grade plastic, the punch doser has a perforated cap for soaking biscuits.



Silicone nonstick supple professional moulds

Moul'flex Pro



- Foodgrade PLATINUM silicone without peroxide guaranteed. For intensive use
- Professional dimensions 400 x 600 mm or GN 1/1.
- For oven cooking and freezing from -40°C/-40°F to +300°C/580°F
- Reduction in cooking time thanks to the AIR SYSTEM® perforations. Perforations localized between the various imprints of the plate for a better heat or cold convection and to obtain: Patented system

Silicone moulds - MOUL'FLEX PRO - mini cakes

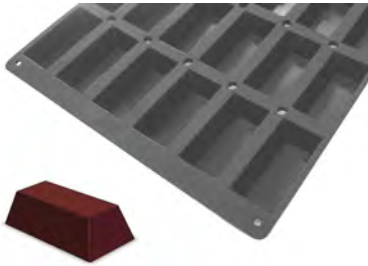

Code	Designation	Lcm	Wcm	Hcm	Kg
	Concept AIR SYSTEM				
1701.53	Tray Gastro GN 1/1 - 20 cakes 10,5 cl	9,7	4,8	3	0,5

Silicone moulds MOUL'FLEX PRO - Hemispherical molds

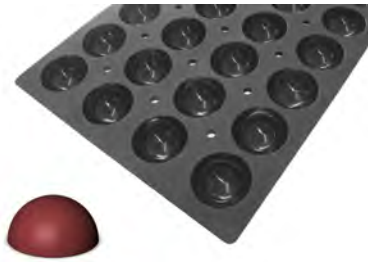

Code	Designation	Øcm	Hcm	Kg
	Concept AIR SYSTEM			
1704.60	Tray 600 x 400 mm - 28 cakes 8,4 cl	7	3,5	0,67
1704.53	Tray gastro GN 1/1 - 18 cakes	7	3,5	0,4

Silicone moulds MOUL'FLEX PRO - portions "Madeleine"



Code	Designation	Lcm	Wcm	Hcm	Kg
	Concept AIR SYSTEM				
1707.60	Tray 600 x 400 mm - 44 cakes 3 cl	7,57	4,2	1,8	0,68

Silicone moulds MOUL'FLEX PRO - portions muffins

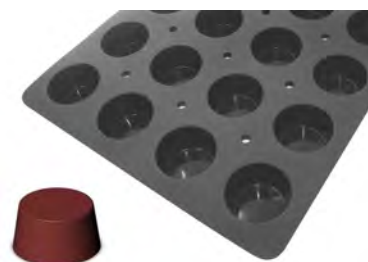

Code	Designation	Øcm	Hcm	Kg
	Concept AIR SYSTEM			
1710.60	Tray 600 x 400 mm - 24 cakes 12,2 cl	6,8	3,5	0,74
1710.53	Tray gastro GN 1/1 - 24 cakes	6,8	3,5	0,54

# FLEXIBLE MOULDS

The De Buyer patented silicone Elastomoule moulds are the flexible moulds chosen by the professionals.

They can be used for anything:  
warm, cold, frozen, sweet or savoury.

---

-232-

MOUL'FLEX PRO

-234-

ELASTOMOULE

-238-

MOUL'FLEX



ELASTOMOULE

1 recipe card supplied with each mould :  
 6 MOF and/or World Champions in Pastry  
 realize their original pastry recipe  
 in the De Buyer's Elastomoule moulds.  
 Made in France ORIGINE FRANCE GARANTIE

ELASTOMOULE



BV Cert. 0151461

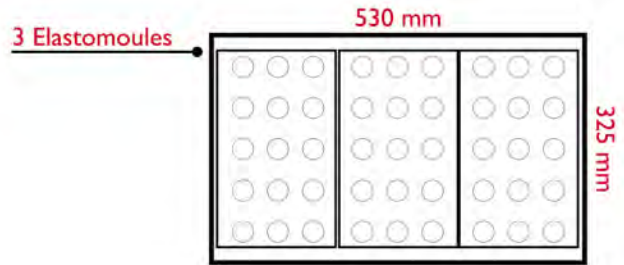
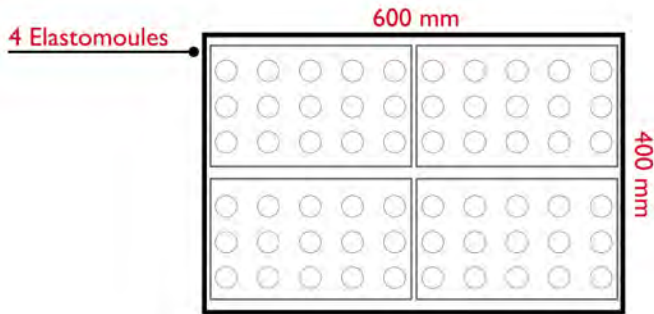

Elastomoule - 40 mini-cylinders ø 27,5 mm



Code	Designation	Øcm	Hcm	Kg
1873.01	Concept AIR SYSTEM 300 x 176 mm 1,4 cl	2,75	2,5	0,26

Silicone moulds ELASTOMOULE - Mini-hemispherical - 1,2 cl



Code	Designation	Øcm	Hcm	Kg
1850.01	Concept AIR SYSTEM 29 x 19,3 cm - 24 cakes	3	1,8	0,11
1850.21	21 x 17,6 cm - 20 cakes	3	1,8	0,1

Silicone foam mould. Non-stick. For cooking in the oven and freezing, from -70°C to 300°C (-90°F to 580°F). Perfect heat transmission, thereby gaining time and allowing juices to caramelize. The mini hemispheres are perfect for making chocolates, dainties, fruit paste sweets.

Elastomoule - 20 MINI Cakes



Code	Designation	Lcm	Wcm	Hcm	Kg
1868.01	Concept AIR SYSTEM Tray 300 x 176 mm 3,15 cl	5	2,7	2,7	0,26





**Silicone moulds ELASTOMOULE - Financier - 4,2 cl**

Code	Designation	Lcm	Wcm	Hcm	Kg
	Concept AIR SYSTEM				
<b>1875.21</b>	21 x 17,6 cm-6 cakes	9,5	4,4	1,2	0,1



Silicone foam mould. Non-stick. For cooking in the oven and freezing, from -70°C to 300°C (-90°F to 580°F). The Elastomoule material transmits heat perfectly and gives a lovely golden appearance to the top and underneath of products while giving them a succulent taste thanks to the caramelization of juices. The mould has sharp angles for a nice appearance.

**Silicone moulds ELASTOMOULE - Mini-financier - 1,05 cl**

Code	Designation	Lcm	Wcm	Hcm	Kg
	1,05 cl				
<b>1852.01D</b>	30 x 20 cm - 25 cakes	4,9	2,6	1,1	0,14
<b>1852.21D</b>	21 x 17,6 cm- 15 cakes	4,9	2,6	3	0,1



Silicone foam mould. Non-stick. For cooking in the oven and freezing, from -70°C to 300°C (-90°F to 580°F). The Elastomoule material transmits heat perfectly and gives a lovely golden appearance to the top and underneath of products while giving

them a succulent taste thanks to the caramelization of juices. The mould has sharp angles for a nice appearance.

**Silicone moulds ELASTOMOULE - Mini-Muffins ø 45 / 38 mm - 3,9 cl**

Code	Designation	Øcm	Lcm	Wcm	Hcm	Kg
<b>1858.01D</b>	30 x 20 cm - 15 cakes 3,9 cl	4,5	30	17,6	3	0,24
<b>1858.21D</b>	21 x 17,5 cm - 9 cakes	4,5	21	17,6	3	0,17



Silicone foam mould. Non-stick. For cooking in the oven and freezing, from -70°C to 300°C (-90°F to 580°F). The Elastomoule material transmits heat perfectly and gives a lovely golden

appearance to the top and underneath of products while giving them a succulent taste thanks to the caramelization of juices. The mould has sharp angles for a nice appearance.

**Silicone moulds ELASTOMOULE - Round mini-tartlet**

Code	Designation	Øcm	Hcm	Kg
	ø 45 mm- 0,95 cl			
<b>1853.01D</b>	30 x 20 cm - 24 cakes	4,5	1,1	0,15
<b>1853.21D</b>	21 x 17,6 cm - 12 cakes	45	1,1	0,1

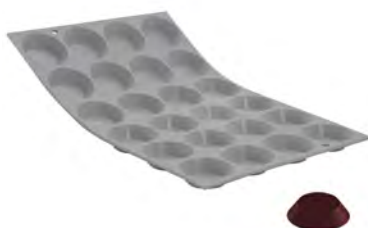

Silicone foam mould. Non-stick. For cooking in the oven and freezing, from -70°C to 300°C (-90°F to 580°F). Perfect heat transmission, thereby gaining time and allowing juices to caramelize. Elastomoule mini jam tart moulds are perfect for making sweet or savory catering products.

**Silicone moulds ELASTOMOULE - Mini-Muffins 'Pomponnette' ø 46/30 mm**

Code	Designation	Øcm	Lcm	Wcm	Hcm	Kg
1862.21	Concept AIR SYSTEM 23,5 x 17,6 cm - 12 cakes	4,6	23,5	17,6	2,4	0,13



**Silicone moulds ELASTOMOULE - Mini-madeleine - 0,64 cl**

Code	Designation	Lcm	Wcm	Hcm	Kg
1851.01D	30 x 20 cm - 30 cakes	4	3	1,1	0,13
1851.21D	21 x 17,6 cm - 20 cakes	4	3	1,1	0,1

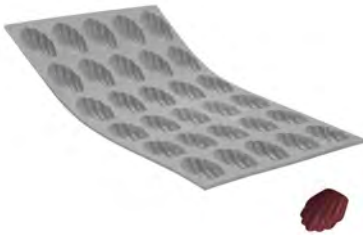

Silicone foam mould. Non-stick. For cooking in the oven and freezing, from -70°C to 300°C (-90°F to 580°F). The Elastomoule material transmits heat perfectly and gives a lovely golden

appearance to the top and underneath of mini Madeleine cakes while giving them a succulent taste thanks to the caramelization of juices that takes place in these moulds.

**Elastomoule - 40 mini-cubes 25 mm**

Code	Designation	Lcm	Wcm	Hcm	Kg
1869.01	Concept AIR SYSTEM 300 x 176 mm 1,5 cl	2,5	2,5	2,5	0,25



**Silicone moulds ELASTOMOULE - Mini-"Bordelais" fluted cake - 1,9 cl**

Code	Designation	Øcm	Lcm	Wcm	Hcm	Kg
1856.01D	Concept AIR SYSTEM 30 x 17,6 cm, 28 cakes - R'SYSTEM 1,9 cl	3,5	30	17,6	3,5	0,31
1856.21D	21 x 17,5 cm - 20 cakes 1,9 cl	3,5	21	17,6	3,5	0,22



The Elastomoule mini Bordelais R'SYSTEM is a BRAND NEW mould. Localized perforations between the indentations give improved

heat convection across the whole plate, resulting in perfect baking.

**Silicone moulds ELASTOMOULE - PORTIONS "Bordelais" fluted cake - 8,2 cl**

Code	Designation	Øcm	Hcm	Kg
1834.01D	30 x 20 cm - 8 cakes 8,2 cl	5,5	5	0,3
1834.21D	21 x 17,6 cm - 6 cakes	5,5	5	0,17



Silicone foam mould. Non-stick. For cooking in the oven and freezing, from -70°C to 300°C (-90°F to 580°F). Perfect heat transmission, thereby gaining time and allowing juices to caramelize. The "Bordelais" Elastomoule Portions give the same

cooking quality and savors as the famous copper molds used for crunchy Bordeaux Cannelé cakes.

**ELASTOMOULE -PORTIONS Madeleine - 3 cl**

Code	Designation	Lcm	Wcm	Hcm	Kg
<b>1832.01D</b>	30 x 20 cm - 9 cakes 3 cl	8	4,5	1,7	0,14
<b>1832.21D</b>	21 x 17,6 cm - 8 cakes	8	4,5	1,8	0,1

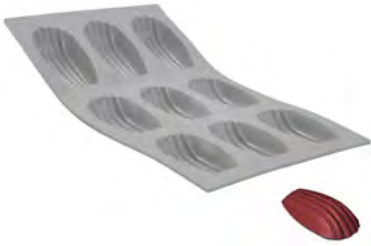

Silicone foam mould. Non-stick. For cooking in the oven and freezing, from -70°C to 300°C (-90°F to 580°F). The Elastomoule material transmits heat perfectly and gives a lovely golden

appearance to the top and underneath of Madeleine cakes while giving them a matchless taste thanks to the caramelization of juices that takes place in these moulds.

**ELASTOMOULE - PORTIONS Cake - 10,5 cl**

Code	Designation	Lcm	Wcm	Hcm	Kg
<b>1831.01D</b>	30 x 20 cm - 9 cakes 10,5 cl	9	4,8	3	0,26
<b>1831.21D</b>	21 x 17,5 cm - 6 cakes	9	4,8	3	0,11



Silicone foam mould. Non-stick. For cooking in the oven and freezing, from -70°C to 300°C (-90°F to 580°F). The CAKE Elastomoule is made from a material that transmits heat perfectly

and gives a lovely golden appearance to the top and underneath of cakes, fruit cakes, and breadrolls while giving them a succulent taste thanks to the caramelization of juices.

**Silicone moulds ELASTOMOULE - PORTIONS Muffins ø 74 / 54 mm - 9,5 cl**

Code	Designation	Øcm	Lcm	Wcm	Hcm	Kg
<b>1833.01D</b>	30 x 20 cm - 6 cakes 9,5 cl	7,4	30	17,6	3	0,16
<b>1833.21D</b>	21 x 17,6 cm - 4 cakes	74	21	17,6	3	0,11



Silicone foam mould. Non-stick. For cooking in the oven and freezing, from -70°C to 300°C (-90°F to 580°F). The Elastomoule material transmits heat perfectly and gives a lovely golden

appearance to the top and underneath of products while giving them a succulent taste thanks to the caramelization of juices. The mould has sharp angles for a nice appearance.

**ELASTOMOULE CUBE**

Code	Designation	Lcm	Wcm	Hcm	Kg
<b>1861.01</b>	Concept AIR SYSTEM minicubes mould - 15 cakes 4 cl.	3,5	3,5	3,5	0,28



The cubic revolution is taking hold in the kitchen, bringing original creations to your plates and shapely formations to your platters. The cube portion mould makes individual preparations, and the mini-cube mould prepares pastries the perfect size to pop in your mouth. Finger food and delicacies at the same time. The Elastocube has been carefully designed to guarantee flawless shapes with

straight lines and geometric angles. It is suitable for both hot and cold use, and will successfully fulfill any and all of your demands

**Silicone mat ELASTOMOULE, smooth relief (10 mm high)**

Code	Designation	Lcm	Wcm	Hcm	Kg
<b>1800.55</b>		55,5	36	1	0,3



Patterned silicone foam tray. Non-stick. For cooking in the oven and freezing, from -70°C to 300°C (-90°F to 580°F). Perfect heat transmission, thereby gaining time and allowing juices to caramelize. The plain tray is perfect for making caramels, fruit paste, etc., which are then cut up using a banjo-wire guillotine.





**FLEXIBLE NONSTICK MOULDS**  
 Foodgrade PLATINUM SILICONE  
 guaranteed without peroxyde  
 -40° to + 280°C (-40° / 530°F)

*Ideal for SWEET and SAVORY HOT,  
 COOL or FROZEN PREPARATIONS*

**MOUL'FLEX - 7 rectangular "Financier" cakes**

Code	Designation	Lcm	Wcm	Hcm	Kg
1976.03	Black tray 295 x 173 mm	9,5	4,5	1,2	0,09



**MOUL'FLEX- Silicone moulds - Rectangular mould Cake**

Code	Designation	Lcm	Wcm	Hcm	Kg
1976.01	BLACK tray 17,5 x 30 cm - 9 Cake moulds 9 cl	9	4,8	3	0,19



**MOUL'FLEX - 25 moulds Mini-Financiers**

Code	Designation	Lcm	Wcm	Kg
1976.02	Tray 17,5x30 cm 1,05 cl	4,9	2,6	0,15



**MOUL'FLEX- Silicone moulds - Mini-"Bordelais" fluted cakes**

Code	Designation	Øcm	Hcm	Kg
1977.01	BLACK tray 17,5 x 30 cm - 28 "Bordelais" cake 1,9 cl	3,5	3,5	0,21



**MOUL'FLEX- Silicone moulds - 8 Bordelais fluted cakes**



Code	Designation	Øcm	Hcm	Kg
1968.01	tray 17,5x30 cm 8,2 cl	5,5	5	0,16



**MOUL'FLEX- 15 Silicone moulds - Hemispherical ø 4 cm**



Code	Designation	Øcm	Hcm	Kg
1961.02	tray 17,5x30 cm 2 cl	4	2	0,1



**MOUL'FLEX- Silicone moulds - Hemispherical ø 7 cm**



Code	Designation	Øcm	Hcm	Kg
1961.01	BLACK 17,5x30 cm - 6 hemispherical moulds 8,9 cl	7	3,4	0,1

The MOUL'FLEX range of flexible silicone moulds offers you a wide choice of baking plates and large individual moulds for making sweet, savory, hot, cold, and frozen preparations.

**MOUL'FLEX- Silicone moulds - 6 Muffins**



Code	Designation	Øcm	Hcm	Kg
1962.01	tray 17,5x30cm 9,7 cl	7,2	3	0,11

MOUL'FLEX is as good for baking as it is for freezing and turns out to be ideal for bain-marie cooking. The silicone is non-stick: there's no need to grease the moulds, and turning out and cleaning are extremely easy.



**MOUL'FLEX- Silicone moulds - Small fluted brioches**



Code	Designation	Øcm	Hcm	Kg
1964.01	BLACK tray 17,5 x 30 cm - 6 small brioches 9,5 cl	8	3,5	0,11

Before first use: - Wash the MOUL'FLEX in soapy water or in the dishwasher - Grease the mould the first time you use it with a little oil or melted butter. For subsequent use, you don't need to grease the mould any more.

**MOUL'FLEX- Silicone moulds - Mini round tartlets ø 5 cm**



Code	Designation	Øcm	Hcm	Kg
1975.01	BLACK tray 17,5 x 30 cm - 15 round tartlets 1,9 cl	5	1,5	0,1

**MOUL'FLEX- Silicone moulds - Madeleines**

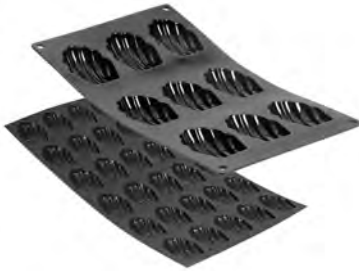

Code	Designation	Lcm	Wcm	Hcm	Kg
1966.01	BLACK tray 17,5 x 30 cm - 9 madeleines 3 cl	7,5	4,5	1,8	0,1
1994.01	Black tray - 17,5 x 30 cm - 30 cakes 0,63 cl	4	3	1,1	0,09

- For use in a heat-circulating oven, place the grille at mid-height in the oven. - For use in a traditional oven, place it near the bottom of the oven instead.

**MOUL'FLEX - Round pie pan**



Code	Designation	Øcm	Hcm	Liters.	Kg
1990.24		24	4,2	1,9	0,17

**MOUL'FLEX - Silicone mould - Rectangular mould CAKE**



Code	Designation	Lcm	Wcm	Hcm	Liters.	Kg
1984.24	BLACK	24	10,5	6,5	1,4	0,16

This mould can be used for making sweet or savory cakes, pâtés, etc.

**MOUL FLEX - Tower**



Code	Designation	Lcm	Wcm	Hcm	Kg
1989.00		26,4	16	5	0,16



# DE BUYER INDUSTRIES TERMS AND CONDITIONS OF SALE - 2023 version

«These terms and conditions of sale apply to all sales made by our company and cannot be cancelled or unilaterally amended regardless of the clauses set forth in the buyer's documents, and in particular their terms and conditions of purchase, over which these terms and conditions of sale take precedence and constitute the basis for negotiations in accordance with the provisions of Article L. 441-6 of the French Commercial Code.»

## 1- DOCUMENTS

All texts, information, characteristics and photographic reproductions included in our prices, catalogues and documentation are for information purposes only and are not guaranteed. We cannot under any circumstances be held liable for any inaccuracies. We reserve the right to make modifications thereto without giving prior notice.

## 2- ORDERS

Orders are not final until they have been confirmed in writing by DE BUYER INDUSTRIES (hereinafter "DE BUYER"). A refusal to confirm an order does not have to be justified by DE BUYER and may occur in the event of an order for an unusual amount or quantity or an abnormal delivery time compared to normal practice in the profession or compared to previous orders.

In the event of a stock shortage, DE BUYER will process orders based on their order of arrival and while stocks last. Any amendment to or cancellation of an order for products from the catalogue, as requested by the client, can only be considered if made in writing at least five (5) working days before the dispatch of catalogue products.

DE BUYER reserves the right to make any amendments to its products that it deems useful at any time and to amend the models in its prospectuses or catalogues without giving prior notice.

## 3- PRICE – MODIFICATION OF FINANCIAL TERMS

3.1. The prices applicable to the buyer are specified in euros, excluding taxes but including packaging, except for special packaging charged for separately, net, and not including transport.

The prices are non-binding and can be modified at any time without notice. Invoicing is carried out according to the price in force on the delivery date (initially agreed) once this price has been communicated to the buyer by DE BUYER before the date of the order. Failing this, invoicing is carried out according to the price in force on the day of the order confirmation, provided that the price is still applicable on the day of delivery (the order confirmation will therefore be considered as being under a condition precedent).

## 3.2.

If, during the execution of an order, the economic, political or health situation, or the conditions of manufacture/production or marketing in force at the time of its conclusion, were (are) manifestly changed, in particular due to a rise in the price of raw materials significantly affecting the market for contractual products, and generally, in the event of a significant change in the economic conditions in force at the time of the order, such as to make the performance of the contract abnormally onerous for DE BUYER, the parties will come together to adapt the terms of this order to the new situation in an equitable manner.

In the event of it being impossible to come to an agreement within a period of two (2) months from the implementation of this clause, the order may be cancelled, by one of the parties, fifteen (15) days after a letter is sent by recorded mail declaring the intention to apply this clause.

This article consequently derogates from Article 1195 of the French Civil Code and expressly excludes recourse to legal proceedings for the purpose of adapting the contract in the event of the renegotiation of the order terms failing. The execution of the order in question will be suspended for the duration of the implementation of this clause.

## 4- DISCOUNTS

The client may receive a discount depending on the quantities purchased or delivered at one time or to one location, or based on the frequency of orders or on special agreements.

## 5- ONLINE MARKETING

By distributing online, the buyer undertakes to take proper care with the sale of the products online and to comply with legal requirements, in particular:

- Only sell products to the retail end user and only process normal requests from this category of buyer;
- Permanently have sufficient stock, stored in conditions that make it possible to meet consumer requests for products, and otherwise to remove products from its offering in the absence of stock allowing it to meet demand;
- Deliver products to consumers based on available stock, limited to two (2) units of the same reference per order;
- Inform the client of the usual delivery times, which should not exceed eight (8) working days from the order being placed online, and the existence of a cooling-off period;
- Indicate the payment, delivery and performance methods as well as the validity of the offer and the price.

By distributing online, the buyer undertakes to respect legislation specific to online sales and general applicable regulations. It undertakes to make transparent offers to the consumer, and to provide advice, assistance and an aftersales service.

## 6- REGULATIONS

- Applicable for France:  
Our invoices are payable within thirty (30) days of the invoice issue date, net, without any discount. For cash payments, i.e. those received within a maximum of ten (10) days after the invoice date, the client can deduct a discount of zero point five percent (0.50%). Excluding outstanding invoices authorised by us, which can be modified at any time, our invoices are payable in advance.

- Applicable for Export:  
The first orders are payable in advance. Any other payment method can only be used after providing commercial references and bank details, and remains subject to the approval of our credit insurance company. Our invoices are then payable within thirty (30) days of the invoice issue date, net, without any discount.  
Any tax, charge, duty or other service payable in accordance with French regulations, or those of an import company or transit company, are payable by the client.

- Applicable for France and Export:  
For orders involving a bespoke product, ordered off plan, one third (1/3) of the amount will be payable in advance as a down payment.  
In the event of a failure to meet a deadline or late payment, all amounts due are immediately payable and all pending orders will be suspended.

Moreover, in light of the terms of Article L. 441-10 of the French Commercial Code, the buyer is automatically required to pay penalties calculated on the amounts due by applying a rate corresponding to three (3) times the legal interest rate in force on the due date, increased by 10%. By virtue of Article L. 441-10 paragraph 5 of the French Commercial Code and in accordance with Article D. 441-5 of the same, a lump-sum indemnity for recovery costs of forty (40) euros is automatically payable by the buyer from the first day of delay. If the recovery costs incurred are higher, an additional indemnity may be requested by the company upon presentation of supporting documents.

If, following a particular agreement, the payment date mentioned on the invoice is after the deadline indicated in the terms and conditions of sale, the date mentioned on the invoice will prevail.

All the above-mentioned terms are covered by credit insurance.  
In the event of non-payment, forty-eight (48) hours after formal notice sent by recorded mail remains without response, the sale will be automatically cancelled if we so choose and we may request, in summary proceedings, the return of the products, without prejudice to any other damages. The cancellation will concern not only the order in question, but also all previous unpaid orders, whether they have been delivered or are out for delivery and whether payment for them is due or not. In the case of payment by paper instrument, failure to return the instrument within the legal timeframe will be considered as non-acceptance equivalent to non-payment. Any client credit deterioration may justify a demand for guarantees or an advance payment before orders received are executed. Payments cannot under any circumstances be suspended or subject to any compensation without the prior written consent of DE BUYER.

## 7- CARRIAGE AND PACKAGING, INSURANCE, DELIVERY

Even for postage-paid shipments, merchandise is always sent at the buyer's risk and it is its responsibility to check goods upon arrival, and if applicable to seek remedy, by recorded mail, from the carriers, who alone are liable for damage, theft, losses or delays.

The buyer is required in to check the visible condition of merchandise upon delivery. If any losses or damage are observed, the buyer must send any claims to the carrier in accordance with Articles L. 133-3 et seq. of the French Commercial Code via recorded mail within three (3) days of delivery, with a copy sent to DE BUYER. No claim can be accepted in the event of non-compliance with these formalities by the buyer. Our delivery times are given for information only and only begin after confirmation of the firm and definitive order. DE BUYER undertakes to respect said timeframes. Delays cannot under any circumstances justify full or partial cancellation of the order or give the client a right of retention or entitle it to damages.

DE BUYER will not under any circumstances be liable to pay direct or indirect damages of any kind arising due to a failure to respect delivery deadlines.

The risks of loss or deterioration of products and any risk of liability related to the existence or use of products are transferred to the client as from dispatch. The client therefore undertakes to purchase insurance to cover products against any risk, in particular fire, theft or water damage.

In the absence of specific dispatch instructions from the client, DE BUYER can have products transported by the carrier of its choice without it being possible for it to be held liable.

Moreover, in the event of manufacturing/production being interrupted due to force majeure, as defined hereafter, orders will be suspended and we cannot be held liable.

## 8- CLAIMS AND RETURNS OF MERCHANDISE

We do not accept any automatic returns. Returns of merchandise are only authorised after written acceptance by us and will be sent postage-paid. Merchandise must have been delivered within the last twenty (20) working days to be eligible. Returns will give rise, after analysis by and a decision from our Quality department, to the replacement of any product recognised as defective by DE BUYER or a credit note which will be issued based on the net price invoiced.

For any return of merchandise due to an error by the client regarding the quantity ordered or code (as proven by the reference number mentioned on the order), we will apply a thirty percent (30%) reduction to the returned merchandise purchase value for restocking costs and shipping costs paid by DE BUYER for dispatch of the merchandise, after quantitative and qualitative

verification of the products.

Restrictions: The following items are not eligible for returns regardless of the circumstances:

- Products damaged, used or stored in unfavourable conditions, or used in an abnormal or inappropriate manner;
  - Bespoke products or orders and products not included in the catalogue.
- Any claim must be made via recorded mail within a maximum of eight (8) working days as from the delivery date. In the event of a claim regarding items, our liability is limited to replacing the defective piece or item, without it being necessary, under any circumstances or for any reason whatsoever, to grant an indemnity of any kind. Shipping costs for pieces or items and the return of defective pieces or items are borne by the buyer.

## 9- CONDITIONS FOR USE OF THE BRANDS AND ADVERTISING MATERIALS

The company owns all intellectual and industrial property rights covering products sold under its brand and/or any other brand used by the company. Commercial relations established between the company and the buyer do not give the buyer any right over advertising materials, brands or any other distinctive company sign. Any use of these elements by the buyer requires the company's prior express written consent.

Use by the buyer of these advertising materials, brands and distinctive signs on commercial documents, in particular advertisements, catalogues, prospectuses, professional directories etc. is subject to DE BUYER's prior express written consent.

In the event of wrongdoing by the buyer in the reproduction or use of one of these elements, DE BUYER will be entitled to claim compensation for the harm suffered.

The buyer undertakes not to carry out promotional campaigns (sales, discounts, promotions etc.) on products supplied under the DE BUYER brand without the prior express written consent of the latter. Any sale of counterfeit merchandise and/or merchandise resembling DE BUYER's merchandise (product itself, packaging, brand, logos etc.) which may lead to confusion in the minds of the public is prohibited.

DE BUYER reserves the right to change the technical properties of products supplied without informing the buyer beforehand. Failure to respect the provisions above can result, if DE BUYER chooses, in the suspension of deliveries, reconsideration of the agreement and/or compensation for harm suffered.

## 10- MANUFACTURING WARRANTY

The products are covered by a one (1) year warranty as from the delivery date.

- It only covers products duly acquired and paid for;
- It applies to products used in normal and suitable conditions and for which a manufacturing defect is observed by our Quality department;
- It does not apply to damaged products or products used or stored in unfavourable conditions, or used in an abnormal, inappropriate manner, or bespoke products;
- It does not apply in the event of visible defects.

In order to assert its rights, the buyer must inform DE BUYER in writing of the existence of defects within a period of one (1) year as from the date on which the defect is observed, under penalty of losing the right to take any related actions.

DE BUYER will replace or repair products or pieces under warranty deemed defective by the Quality department. The replacement of defective products or pieces will not give rise to an extension of the warranty specified above.

The buyer alone is liable for patents and counterfeits with respect to special items made based on models or designs provided by the buyer.

In a bid to improve quality, we reserve the right to make any changes to our items that we deem necessary.

## 11- PENALTY CLAUSE

The buyer undertakes to pay, under the penalty clause, in accordance with Article 1231-5 of the French Civil Code, a lump-sum indemnity of fifteen percent (15%) excluding taxes of the agreement, in the event that it does not perform one of its obligations. The penalty is indivisible and payable to DE BUYER, even if the latter requests the cancellation of the agreement. This clause does not prevent DE BUYER from taking legal action to obtain compensation for all harm suffered due to non-performance if said harm exceeds the amount of the penalty clause.

## 12- RETENTION OF OWNERSHIP

In the event of non-payment by the client of all or part of the price of the order, DE BUYER retains, until payment is made in full, property rights over the products sold, allowing it to take back possession of said products. Any down payment made by the client will remain the property of DE BUYER as a lump-sum indemnity, without prejudice to any other action it may be entitled to bring against the client in this respect. Consequently, the transfer of product ownership to the buyer will only take place upon full payment of the price by the latter, regardless of the delivery date of said products.

## 13- NON-PERFORMANCE EXCEPTION - FORCE MAJEURE

13.1. DE BUYER is automatically released from its obligations if the terms of payment have not been observed by the buyer.  
13.2. The parties cannot be held liable if the non-execution or the delay in the execution of any of their obligations, as described herein, with the exception of the obligation to pay a sum of money, results from a case of force majeure within the meaning of Article 1218 of the French Civil Code.

By force majeure, the parties understand, in addition to the cases usually recognised by French law and case law, the following events: labour disputes, total or partial strikes at the company or its suppliers, service providers, carriers, postal services or public services, suspension or cessation of carrier activity, unavailability of energy, difficulty or impossibility of supplying raw materials or packaging/manufacturing/production/delivery of orders, in particular in connection with the increase in the cost of raw materials/packaging or the increase in delivery times or shortages of raw materials/packaging, imperative injunction from public authorities (import ban, embargo, containment, traffic restrictions, health measures...), operating accidents, machinery breakdown, explosion, war, armed conflict, attack, earthquake, requisition, fire, flood, machinery accidents, failure or insolvency of a supplier or subcontractor, pandemic or epidemic known or unknown on the day of the conclusion of the contract, illness of employees, exceptional health measures impacting manufacturing/production.

The party experiencing the event must immediately inform the other party that it is impossible to perform its obligation and justify this to the other party. The suspension of the obligations can in no case be a cause of liability for non-execution of the obligation in question, nor induce the payment of damages or late payment penalties.

The performance of the obligation is suspended for the duration of the force majeure event if it is temporary and does not exceed a period of 90 calendar days. Consequently, as soon as the cause of the suspension of their reciprocal obligations disappears, the parties will make every effort to resume the normal performance of their contractual obligations as quickly as possible. To this end, the party obstructed will warn the other of the resumption of its obligation by recorded mail or any extrajudicial document.

If the impediment is definitive or exceeds a period of 90 calendar days, the order(s) will be purely and simply cancelled, eight (8) days after receipt of a letter notified sent by recorded mail by the first party to act. However, this letter must mention the intention to apply this clause.

## 14- PERSONAL DATA PROCESSING

DE BUYER, the data controller, processes the data of employees and/or client partners in the context of commercial relations with clients whose purpose is the negotiation, completion, management, tracking, preparation and dispatch of orders, plus invoicing, accounting and recovery, as well as the sending of commercial and/or advertising information.

Pursuant to the conditions set out in the French Data Protection Act and the European General Data Protection Regulation (or GDPR), data subjects have the right to access their personal data, request rectification, erasure and minimisation and, as may be relevant, exercise the right to portability.

Data subjects are also entitled to provide general and specific instructions specifying the way in which they expect the rights mentioned above to be exercised after their death.

Pursuant to the conditions provided for by law and the GDPR, if the legal basis of processing is in the legitimate interest of the company, unless the company demonstrates the existence of compelling and legitimate reasons for this processing which prevail over the interests, rights and freedoms of the data subject, subjects can also, for reasons related to their specific situation (legitimate grounds) object to the processing of their personal data.

To exercise these rights or for any other question regarding the processing of personal data, data subjects can contact: info@debuyer.com

Data subjects are entitled to complain to the French Data Protection Authority, the Commission Nationale de l'Informatique et des Libertés (CNIL).

For more information, please see the PERSONAL DATA PROCESSING POLICY, which is available upon request.

## 15- HOUSEHOLD PACKAGING RECYCLING INFORMATION

Pursuant to article L.541-10-13 of the French Environmental Code, the unique identifier FR212339\_01VSBE attesting to inclusion in the register of producers in the packaging sector has been assigned by SYDEREP (ADEME) to DE BUYER. This identifier certifies that it has met its obligation to join the register of packaging producers and makes its market declarations via CITEO.

## 16- DISPUTE SETTLEMENT AND JURISDICTION

THE EPINAL COMMERCIAL COURT (88 France) ALONE HAS JURISDICTION, including in the case of a third-party claim or multiple defendants. The only governing law is French law. The French version of these terms and conditions of sale prevails over the English version.

To pay our invoices:

Banque CIC F-70 000 VESOUL  
IBAN : FR76 3008 7331 8200 0212 9910 108  
BIC : CMCIFRPP

Banque KOLB SA F-88500 MIREOUCOURT  
IBAN : FR76 1325 9023 2010 2718 0020 048  
BIC : KOLBFR21 - SWIFT : NORDFRPP

# IN THE SHOP

# POS / POS

# COOKING

## SEASONING STEEL SHELF TALKER

Dim. 190 x 110 mm  
 10.5620 - French  
 10.5621 - English  
 10.5622 - German  
 10.5623 - Flemish  
 10.5624 - Danish



## KIT SHOP WINDOW DE BUYER 5 podiums :

- 1 x High 50 cm
  - 2 x High 35 cm
  - 2 x High 20 cm
  - + 1 Totem 73 x High 200 cm
- 2 sides :  
 - Steel Mineral B  
 - Choc B Bois  
 REF 10.0008



## ALCHIMY POP

Kit shop window  
 Totem 2 sides Dim. 35 x 65 cm  
 + 3 podiums High 10 / 15 et 22 cm  
 REF 10.3600



## BROCHURE ALCHIMY

Tips and recipes  
 Dim. 20 x 20 cm  
 REF 10.3601 FR/ EN  
 REF 10.3602 FR/ NL/ SP  
 REF 10.3603 FR/ DE/ IT



## MODULAR PODIUM CHOC RETAIL (CHOC EXTRÊME / CHOC B BOIS AND CHOC INTENSE)

Dim. 30,5 x 29,5 x High 47 cm  
 REF 10.8300

## NONSTICK BROCHURE CHOC RETAIL

Tips and recipes  
 REF 10.8301 - French  
 REF 10.8302 - English



## STEEL BROCHURE MINERAL B & OUTDOOR RETAIL

Tips and recipe  
 REF 10.5001 - French  
 REF 10.5003 - German  
 English version available in PDF



## FLYERS PRODUCT RANGES (French - English - German)

Dim. 10,5 x 21cm  
 REF

- (1) QET37.001 - AFFINITY collection
- (2) QET62.000 - PRIMA MATERA collection
- (3) QET56.000 - MINERAL B collection
- (4) QET87.000 - B BOIS collection (MINERAL B / CHOC / utensils and mills)
- (5) QET87.001 - CHOC INTENSE collection
- (6) QCD21.010 - Pastry nozzles collection (Tritan and st. steel)

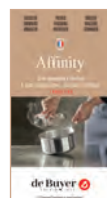

## BBQ / OUTDOOR POP

POP kit includes in the OUTDOOR concept which contains :  
 1 cardboard flag + 2 shelf covers + 1 chain.



TOTEM 2 sides  
 Dim. 159 x 54 cm  
 REF 20.500



## CARDBOARD FLAG

Dim. 18 x 60 cm  
 REF 20.501



## SHELF COVER

Dim. 40 x 3,5 cm  
 REF 20.502



## BBQ BROCHURE

Use and recipes  
 Dim. 20 x 20 cm  
 REF 20.504



CHAIN 3 rounds  
 REF 20.503

## BOOST YOUR SALES AND DEVELOP YOUR STORE

Training and Masterclass catalogue download :



FORMATIONS & MASTER CLASS





### FABRIC KAKEMONO

- Wooden rod finishing and supporting cord
  - Single side printed in French
  - Indoor use
- Dim. 90 x 40 cm  
REF
- 10.1001 Cooking steel POP  
10.1003 Cooking st. steel and copper POP  
10.1002 POP Pastry

# POP / POS PASTRY

### POSTER TO HANG

Le Tube and piston funnel  
KWIK - 2 sides - with hook  
system  
Dim. 60 x 40 cm  
REF 10.3350



Recto

Verso

### CARDBOARD FLAG

Dim. 18 x 60 cm  
REF 21.470



### RECIPES BOOK 'GEOFORME'

4 languages (French / English /  
German and Spanish)  
Dim. 120 x 180 mm  
REF 10.3210



### SHELF COVER

Perforated st. steel rings  
French and English  
l. 40 - 3,5 cm - REF 21.471



### KAKEMONO POSTER AIR' SYSTEM

2 sides to hang with hook system  
Dim. 60 x 40 cm  
REF 10.3230



### AIR' SYSTEM FLYER

Air'System collection, concept  
and tips.  
Dim. 10,5 x 21 cm  
REF 10.3000 - Français  
English and German  
versions available in PDF.

### POP SHELF TALKER

Perforated st. steel rings  
French / English  
Dim. 190 x 110 mm  
REF 10.3090



# DIVERSE

### CSR INFO POSTER TO HANG

with hook system  
French / Dim. 60 x 40 cm  
REF 20.105



Recto

Verso



### COUNTER DISPLAY

2 sides / French  
Dim. 15 x 21 cm  
REF 20.104

### KRAFT PAPER BAG

Dim. 36 x 36 cm  
REF. QSP50.080



Learn more about our  
commitment :



### BROCHURE HOLDER

made of plexiglass for  
information sheets  
Dim. 10.5 x 21 cm  
REF FRP09.621



### BRAND RECALL

Beechwood  
L. 21 x 6 x 2.5 cm  
REF. 10.0006



# DISPLAYS

## 1 • DISPLAY 'UNIT TOWER' 4 SIDES 5000.09

For a lively boutique with an original, eye-catching display. Emphasize the value of 'Made in France' !

Dim. 60 x 60 cm / High 200 cm  
Differents compositions available  
Option : video screen 5000.96  
This display is available with removable tables and hooks and can be used to display any choice of range :

- PRIMA MATERA
- AFFINITY
- ALCHIMY / MILADY
- ELASTOMOULE
- MINERAL B
- B BOIS

Display example for B Bois  
REF 5000.09C



Display example PRIMA MATERA  
REF 5000.09 with screen 5000.96

## 2 • RETAIL DISPLAY

Elegant and practical for setting up a corner dedicated to the brand de Buyer for a high-end presentation.  
2 versions : wall display and central display.



### WALL DISPLAY 5000.20

- 90 x 47,5 cm / High 185 cm
- Modular equipping according to product ranges.
- 4 removable shelves
- 15 removable hooks
- Equipped with a drawer on wheels
- LED lighting (transfo 230/12V 60 W)



### CENTRAL DISPLAY 5000.25

- 118 x 78 cm / High 155 cm
- 2 sides on wheels
- 3 removable hooks



## 3 • SPECIAL HORECA STOCKIST

Grid large display REF. 5000.00  
High 255 cm - Width 130 cm - Deep 60 cm.  
Weight : 68 kg empty - possible load : 500 kg.  
Standard hooks : 27 cm long, Ø 8 mm.

*Consult us for the composition of displays and the conditions to have a display at disposal*



# DIGITAL TOOLS

Discover your professional space and all its benefits on our website

**PRO.DEBUYER.COM**

- Available 24h/24
- Customizable space
- Uploading of Excel files
  - Order history
  - Responsive
- Autonomy in ordering

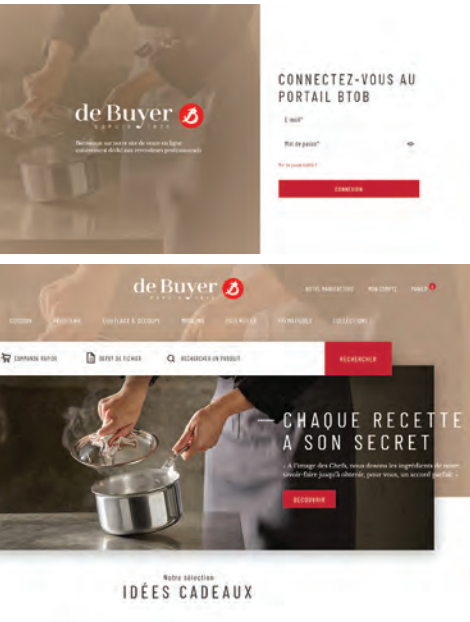

De Buyer hosts its photos and videos on JOOMEO

**JOOMEO.COM**

Joemo is a simple storage platform without pressure.

De Buyer space  
User name : Debuyer  
Password : France

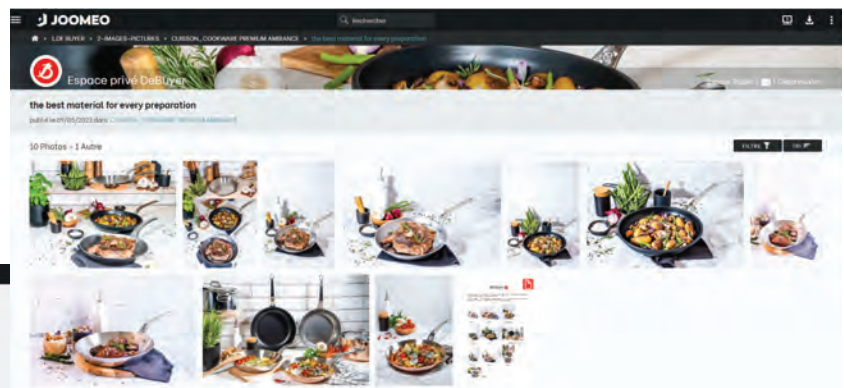

You can easily search, view and download our content on computer or mobile.  
De Buyer provides you with rich and varied content, photos and videos, to illustrate all of its products.



# ALPHABETICAL INDEX

## A-B

Bag (pastry bag)	227, 228, 229
Bag holder	227
Bain-marie	69
Bain-marie cooker	211
Baker blade	209
Baking paper	208
Baking tray	203, 204, 205
Basket	20
Basting spoon	118, 120
Blini pan	11, 15, 16, 18, 48
Bottle	231
Bowl	30, 104
Bowl, round	104
Bucket	107, 108
Burner	29

## C

Candy Thermometer	131, 212
Caramelizing iron	231
Chestnut fry-pan	28
Chinese strainer	105, 106
Cleaner for metal	56, 99, 134
Colander	105
Cover	26
Crepe pan, nonstick	41, 43, 45, 47, 80
Crepe pan, steel	11, 15, 18, 21, 28, 81
Cutter vegetable	165
Cutter	209
Cutting board	171

## D-E

Dariole mould	182
Decor sheet	212
Deep fryer	20
Dish	30, 97, 105
Dispenser LE TUBE	111, 112, 219
Dough scraper	210
Dough wheel	209, 210
Dredger	32, 107
Egg dish	97

## F

Filter for funnel	109
Fish frypan	46, 47

Flour scoop	108
Frypan, copper	86, 90, 91, 94, 96
Frypan, nonstick	37-51, 76, 80
Frypan, stainless steel	57, 61, 65, 75, 78
Frypan, steel	9-21, 27, 28, 77, 81
Funnel	109, 213

## G

Gel alcohol	134
Genoise cutter	126
Génoise frame	181
Glove	21, 39, 51, 128, 135
Grate	201, 206

## H

Handle, removable	73, 78, 79, 81
Hanging bar	117

## I-J-K

Ice-cream scoop	109
Jam pan, copper	99
Knife	30, 168, 169, 170

## L

Ladle	117, 118, 119
Lid, copper	89, 94, 96
Lid, stainless steel	13, 59, 63, 68, 75, 89, 92
Lid, glass	11, 14, 39, 41, 42, 63, 65, 75, 79
Lobster fork	128
Long rolled cake mold	176, 177

## M

Meat fork	118
Mill	107, 140-151
Mould, stainless steel	178-182
Mould, steel	188
Mould, nonstick	183-187
Mould Canelés	99, 181, 182
Mould "Charlotte"	182, 184
Mould for pie	180, 183, 188
Mould, hemispherical	182
Mould silicone	232-240
Mug (Army)	33



<b>N</b>			
Nozzles	214-222	Scraper	210
Nutmeg mill	147	Self-service dish	33
<b>O</b>		Sieve	106
Omelette turner	117	Silicone mat	206, 207
Oval pan	97	Silicone moulds	232-240
Oven peel for "Flammenküche"	130	Sirup density meter	131
Oyster knife	128	Skewer	31, 120
<b>P</b>		Skimmer	117, 118, 119
Pastry bag	228, 229	Slicer (vegetable)	156-164
Pastry brush	31, 230	Smoker oven	33
Pastry frame	195	Spatula	31, 32, 51, 114, 115, 119, 120, 124, 125, 126
Pastry spatula	125	Spices mill	33, 139, 147, 150, 151
Pepper/salt mill	140-151	Stand for wok	69
Piston funnel	112, 113	Steamcooker	58, 62, 64, 68, 74, 79, 88
Pizza cutting wheel	32, 129	Stewpan, copper	88, 90, 93, 95, 97
Pizza oven peel	130	Stewpan, nonstick	38
Plancha	16, 19, 25, 26	Stewpan, stainless steel	58, 62, 64, 67
Plastic scraper	210	Stewpan, oval	59
Pusher	106, 199, 237	Stockpot	68, 87, 95
<b>R</b>		Strainer	107
Rack for cutting boards	171	String	134
Raplette, sliding & egalizing	196	Sugar saucepan	212
Relief sheet	177, 212	Sweet maker	211
Ribbon	197	<b>T</b>	
Ring, pastry	193-201	Tart ring	189-193
Ring, tart	189-193	Thermometer	131, 132, 133
Roasting pan	16, 48, 59, 93	Timer	133
Rolling pin	209	Tomato-slicer	166
<b>S</b>		Tray	203-205
Salt shaker	146	Tray for baguette	187, 188, 205
Saucepan, copper	85, 89, 91, 94, 96, 98	Trivet	29
Saucepan, stainless steel	56, 60, 65, 66, 74, 78	Tube mould	231
Sauté-pan, copper	85, 86, 87, 89, 90, 92, 94, 96, 97	Tweezer	30, 115, 120, 121
Sauté-pan, nonstick	38, 39, 41, 43, 48, 76, 80	<b>W</b>	
Sauté-pan, stainless steel	57, 58, 61, 65, 67, 75, 76, 79	Whisk	123
Sauté-pan, steel	9, 10, 13, 81	Wok, copper	88
Scales	131	Wok, steel	11, 14, 19
Scharpener	171	Wok, stainless steel	39, 58, 63, 69
Scissors	127	<p><i>All texts, information, characteristics and photographs in this catalogue are for information only and are not warranted. We disclaim liability in event of inaccuracy thereof. We reserve the right to make any changes therein without prior notice.</i></p> <p><b>Credits photos :</b> Eric Marin - Bella Karragiannidis de Buyer Industries - Studio Julien Bouvier - Lézards'Création</p> <p>Thanks to Atelier TB, Bragard, Febvay France, Garnier-Thiebaut, REVOL.</p>	

# NUMERICAL INDEX

Code	Page	Code	Page	Code	Page	Code	Page	Code	Page	Code	Page	Code	Page	Code	Page
0237	201	1975	240	2601	117	3136	117, 129	3351	105	3504	66	3940	193	4281	168, 169
042002	197	1976	238	2610	123	3139	199	3352	106	3505	67	3941	198	4282	169
042003	197	1977	238	2611	123	3141	119	3353	112	3506	68	3942	198	4283	170
042004	197	1984	240	2612	167	3142	119	3354	105, 113	3507	68	3943	198	4284	170
042005	197	1989	240	2701	116	3150	119	3356	109, 213	3509	63, 68	3979	33	4285	30
042011	197	1990	240	3000	231	3170	118	3357	109	3565	108	3982	118		169, 170
042016	197	1994	240	3002	196	3201	205	3358	11, 112	3601	60	3983	118	4286	170
042024	197	20	24	3005	231	3204	176		218, 219	3602	61	3984	119	4287	169
042026	197	2000	157	3006	189-199	3205	176	3360	205	3603	61	3985	119	4290	171
042032	212	2004	107		230	3206	176, 177	3361	204	3604	61	3989	32, 74	4291	171
044085N	231	2005	166	3007	231	3208	181	3366	205	3605	62	4021	108	4304	209
0816	29	2007	107	3013	195	3210	178	3367	205	3608	63	4111	11, 41	4307	209
0820	29	2011	30, 164	3015	195	3212	180	3371	104	3660	73	4112	58, 79	4308	209
1701	232	2012	156, 157	3021	118	3213	179	3372	104	3661	74	4140	171	4336	229
1704	232	2014	162	3027	199	3214	180	3373	104	3662	75	4150	217, 218	4337	134
1707	232	2015	157,	3030	175, 192	3215	180	3374	26	3663	75	4151	214	4338	134
1710	232	159, 161,	162, 163	3031	192	3221	33	3379	104	3675	58, 62	4152	215	4343	177, 212
1800	237	2016	160, 161	3032	192	3232	105	3390	69		64, 68, 74	4153	215	4344	178- 181, 208
1831	237	2017	158,	3037	198	3242	107	3401	31, 120		79, 88	4155	214	4346	229
1832	237		159, 162	3040	194	3250	30, 104	3410	65	3706	56	4156	214	4347	227, 228
1833	237	2018	165	3041	118	3271	108	3411	65	3709	59, 86, 92	4165	216	4348	228, 229
1834	236	2040	231	3065	181	3274	108	3412	65	3718	57	4166	215	4349	229
1850	234	2111	220	3069	198	3276	107	3427	64	3724	57	4168	215	4357	208
1851	236	2112	220, 221	3076	199	3280	105	3428	63, 75	3726	59	4180	216	4358	208
1852	235	2113	222	3077	197, 199	3283	30, 105	3429	14, 39	3727	59	4181	216	4359	208
1853	235	2114	225,	3091	193	3290	130		42, 58, 65, 76	3730	57	4182	216	4361	209
1856	236		226, 227	3093	192	3293	130		88, 184	3736	57	4183	216	4362	209
1858	235	2115	222	3095	182	3294	117	3437	69, 211	3741	58	4200	99, 134	4370	108
1861	237	2116	224	3096	198	3300	210	3441	33	3742	58	4230	125	4409	134
1862	236	2117	221	3098	189, 190	3301	210	3460	13, 38,	3743	58	4231	125	4420	25, 26
1868	234	2118	222	3099	189-191	3302	210		51, 75, 76	3745	58	4232	32, 126	4441	33
1869	236	2119	223		198	3320	205		77, 98	3746	56	4233	31, 126	4530	104
1873	234	2120	224, 225	3111	69	3321	204	3491	78	3905	196, 198	4234	126	4591	131
1875	235	2125	225	3122	19, 69	3323	209	3493	79	3906	196, 198	4235	31, 126	4604	106
1961	239	2126	223	3125	182	3324	209	3495	79	3912	194	4236	126	4605	106
1962	239	2128	223	3130	119	3329	11, 14,	3500	211	3930	105	4237	121	4636	21, 39
1964	239	2129	223	3133	182		39, 58, 63, 88	3501	66	3937	199	4238	121		51, 135
1966	240	2130	226	3134	117	3330	206	3502	67	3938	198	4239	30, 121	4650	133
1968	239	2140	120	3135	117	3350	105, 106	3503	67	3939	198	4280	30, 169	4670	209

Code	Page	Code	Page	Code	Page	Code	Page	Code	Page	Code	Page	Code	Page
4682	128	4826	109	5140	18	5681	9	6453	98	8310	38	M516	147
4683	127, 128	4827	109	5303	21, 28	5684	9	6454	98	8311	38	P222	148
4685	127	4840	209	5320	203	5710	10	6460	94	8313	39	P223	148
4687	128	4843	186	5321	203	5712	11	6462	94	8317	39	P224	148
4700	184	4844	186	5350	32, 200	5714	10	6463	89, 94	8320	38, 201	P230	139
4701	185	4856	228	5353	200	5715	11	6464	94	8359	78, 81		144, 145
4702	185	4858	210	5356	188	5718	11	6465	94	8360	79	P240	146
4703	184	4859	228	5357	188	6200	99, 213	6466	95	8364	76	P245	140, 141
4705	183	4870	114	5358	188	6202	99, 213	6467	95	8365	76	P246	141
4706	183	4871	114	5359	188	6206	85	6468	95	8440	45	P247	142
4707	183	4872	114	5362	203	6224	86	6572	212	8450	45	P249	142
4708	184	4873	115	5363	203	6230	85	6580	99	8460	45	P251	143
4709	184	4874	115	5400	27	6232	87	6820	99, 182	8470	45	P253	142
4710	186	4875	115, 130	5408	28	6236	86	7291	130	8480	44	P256	143
4711	186	4876	115	5414	27	6241	87	7293	130	8485	45	P292	139, 147
4712	186	4881	132, 133	5440	27	6242	88	7350	129	8740	80	S322	148
4713	174, 175	4882	132	5490	28	6243	87	7360	203	8745	80	S323	148
	187	4884	131, 212	5491	28	6244	87	7362	203	8748	80	S324	148
4714	187	4885	131, 132	5493	28	6247	88	7366	200	8760	42	S330	139
4715	187	4887	131	5530	19	6306	89	7367	204	8765	43		144, 145
4716	187	4891	124	5540	19	6324	90	7368	204	8768	43	S340	146
4717	185	4920	171	5610	7, 12	6330	89	7664	48	8780	40	S345	140, 141
4718	185	4931	206	5611	15	6332	90	8030	51	8785	41	S346	141
4719	184	4935	207	5612	7, 15, 16	6336	90	8040	49	8788	41	S347	142
4720	117	4937	207	5613	12	6342	90	8050	49	C030	33, 139	S349	142
4740	124	4938	206	5614	13	6406	91	8060	49		144, 145	S351	143
4745	124	4970	6, 32, 129	5615	6, 15	6424	91	8070	49	C040	146	S353	142
4761	132	5020	20	5616	13	6427	93	8136	201	C045	140, 141	S392	139, 147
4766	186	5023	29	5618	14	6430	92	8137	201	C046	141		
4770	181	5026	29	5619	14	6436	92	8140	48	C047	142		
4781	210	5050	20	5630	81	6441	92	8161	204	C049	142		
4782	107	5051	20	5634	81	6442	93	8162	204	C084	151		
4783	32, 107	5110	17	5635	81	6445	96, 98	8180	47	C086	150		
4788	30, 120	5111	18	5640	16	6446	97	8181	47	C087	151		
4805	230	5113	19	5651	16	6447	97, 98	8184	47	C092	139,		
4807	31, 230	5114	19	5652	16	6448	96	8185	47		147, 151		
4813	51, 120	5120	18	5654	13	6449	97	8188	48	C192	151		
4815	109	5130	17	5664	77	6450	96	8300	37	M245	140		
4816	120	5131	18	5680	9	6451	97	8304	38	M340	146		





de Buyer Industries  
25, Faymont - 88340 Le Val d'Ajol - FRANCE  
TEL: + 33 (0)3 29 30 66 12  
info@debuyer.com - www.debuyer.com  
SIRET 403 467 574 00014 TVA FR68 403 467 574



\*Every recipe holds a recipe